



Cipriani Harrison Valves Corp.

Fractional Butterfly Valve 101 Series

Application

Stainless steel hygienic butterfly valves are used in process piping systems for isolation and control. Butterfly valves operate either manually or automatically.

Working Principle

Quarter turn (90° rotation) operation closes or opens the valve. A wide variety of handles allow the valve disc to be set at various positions so that the flow rate can be regulated.

Standard Design

The valve consists of two valve bodies and a disc made from forged stainless steel which ensures a non porous, smooth surface and dimensionally stable construction. The valve disc has a dense and polished surface which combined with a slim design allows for a high CV. The PTFE stem bushing ensures an extra smooth disc rotation. All Seats and Seals are made from FDA approved materials. The valves are assembled by means of allen head cap screws.

Available Sizes

1/2", 3/4"

Options

Variety of multiple position handles for manual operation
(Please see page No. 5)

End connections: Sanitary Clamp, Butt-Weld,
others on request.

Material: AISI 316L or AISI 304L

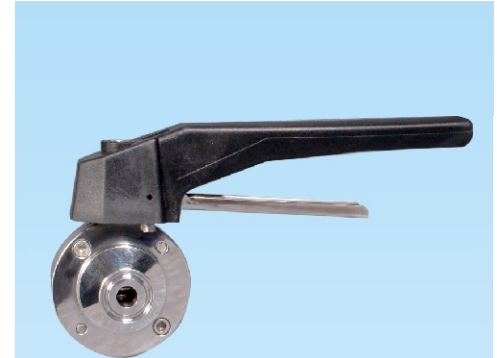

 *Cipriani Harrison Valves Corp.*

30271 Tomas Street • Rancho Santa Margarita, CA 92688 • Tel. 949/589-3978 • Fax 949/589-3979
Email : cipriani@ciprianicorp.com • Website : <http://www.ciprianicorp.com/>

Fractional Butterfly Valve

101 Series

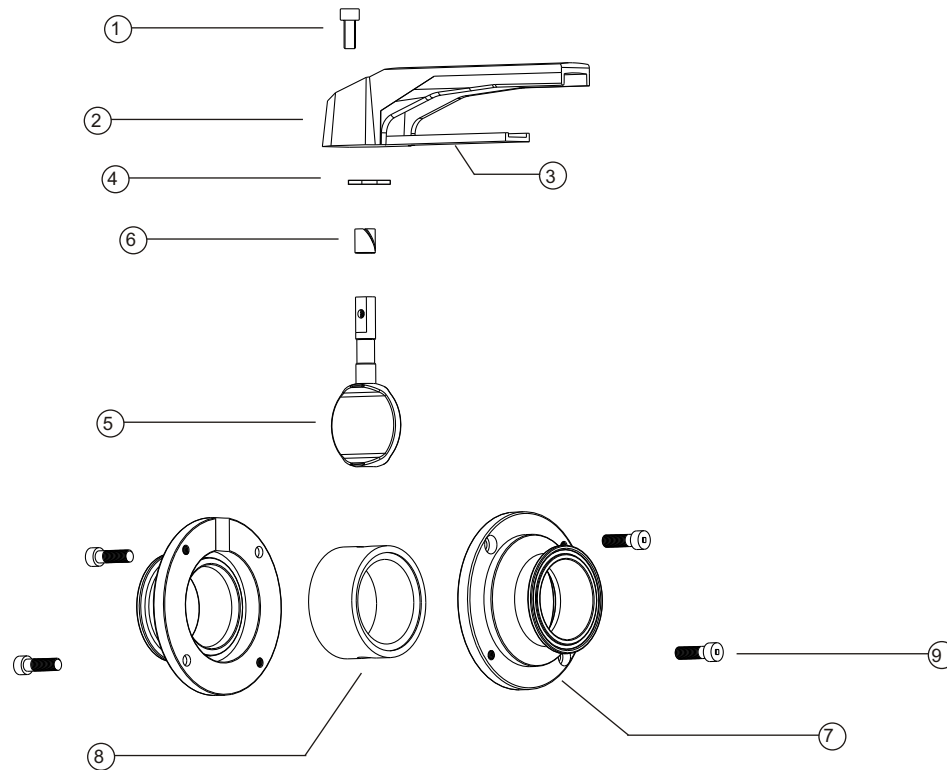

Exploded view of Fractional Butterfly Valve

NO.	PART NUMBER	DESCRIPTION	MATERIAL
1	1011	SCREW	AISI 304
2	1012	HANDLE	Reinforced Polymer
3	1013	TRIGGER	SS 304
4	1014	WASHER	SS 304
5	1015	DISC	AISI 316L
6	1016	BUSHING	PTFE
7	1017	FLANGE	AISI 316L or AISI 304L
8	1018	SEAT	SILICONE
9	1019	SCREW	AISI 304

 **Cipriani Harrison Valves Corp.**

30271 Tomas Street • Rancho Santa Margarita, CA 92688 • Tel. 949/589-3978 • Fax 949/589-3979
 Email : cipriani@ciprianicorp.com • Website : <http://www.ciprianicorp.com/>

Fractional Butterfly Valve

101 Series

Dimensions (Inches)

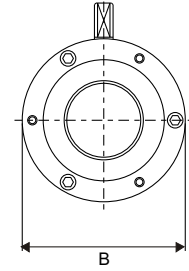
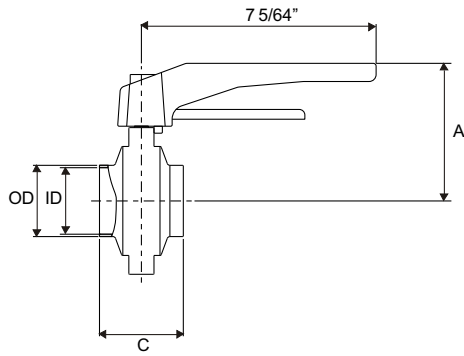

Butt-Weld

Dimensions	A	B	C	OD	ID
1/2"	3 5/64	2 9/16	2 33/64	1/2	3/8
3/4"	3 5/64	2 9/16	2 33/64	3/4	5/8

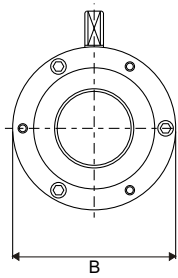

Sanitary Clamp

Dimensions	A	B	C	ID
1/2"	3 5/64	2 9/16	2 33/64	3/8
3/4"	3 5/64	2 9/16	2 33/64	5/8

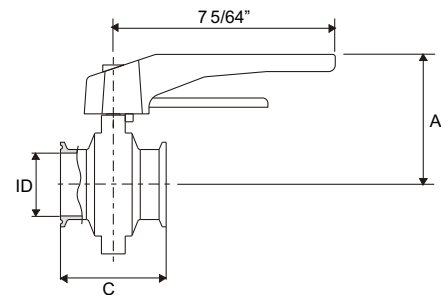

 **Cipriani Harrison Valves Corp.**

30271 Tomas Street • Rancho Santa Margarita, CA 92688 • Tel. 949/589-3978 • Fax 949/589-3979
 Email : cipriani@ciprianicorp.com • Website : <http://www.ciprianicorp.com/>

Fractional Butterfly Valve

101 Series

Handles

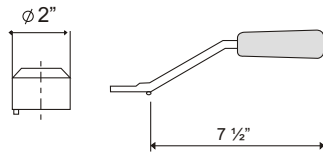

Removable Handle (7M1)

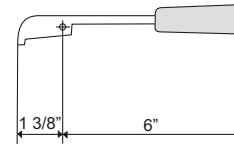

2 Position Old Style (7M2) (Fang)

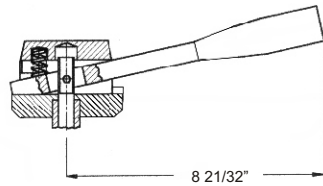

2 Position S.S. (7M3)

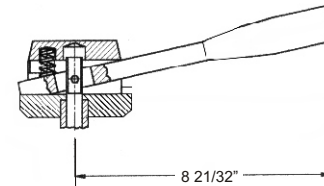

10 Position S.S. (7M4)

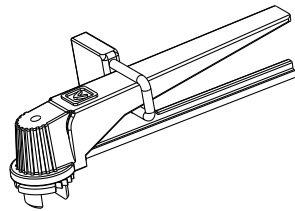

Multi Position Lockable Handle (7M5)

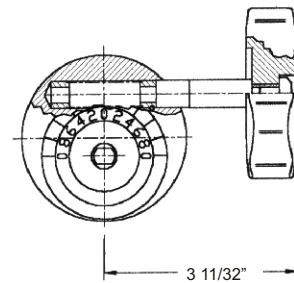

Micro-Metric (fine tuning) (7M6)

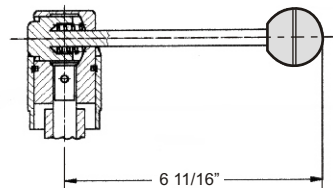

2 Position Pull Type (7M7)

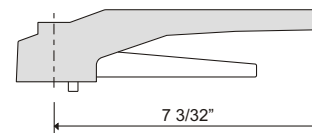

Black - Standard 2 Position (7M8)
(Optional Color - Blue)

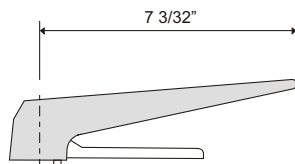

Black - Old Standard 2 Position (7M9)

 **Cipriani Harrison Valves Corp.**

30271 Tomas Street • Rancho Santa Margarita, CA 92688 • Tel. 949/589-3978 • Fax 949/589-3979
Email : cipriani@ciprianicorp.com • Website : <http://www.ciprianicorp.com/>

Fractional Butterfly Valve

101 Series

101 Series Fractional Butterfly Valve Ordering System

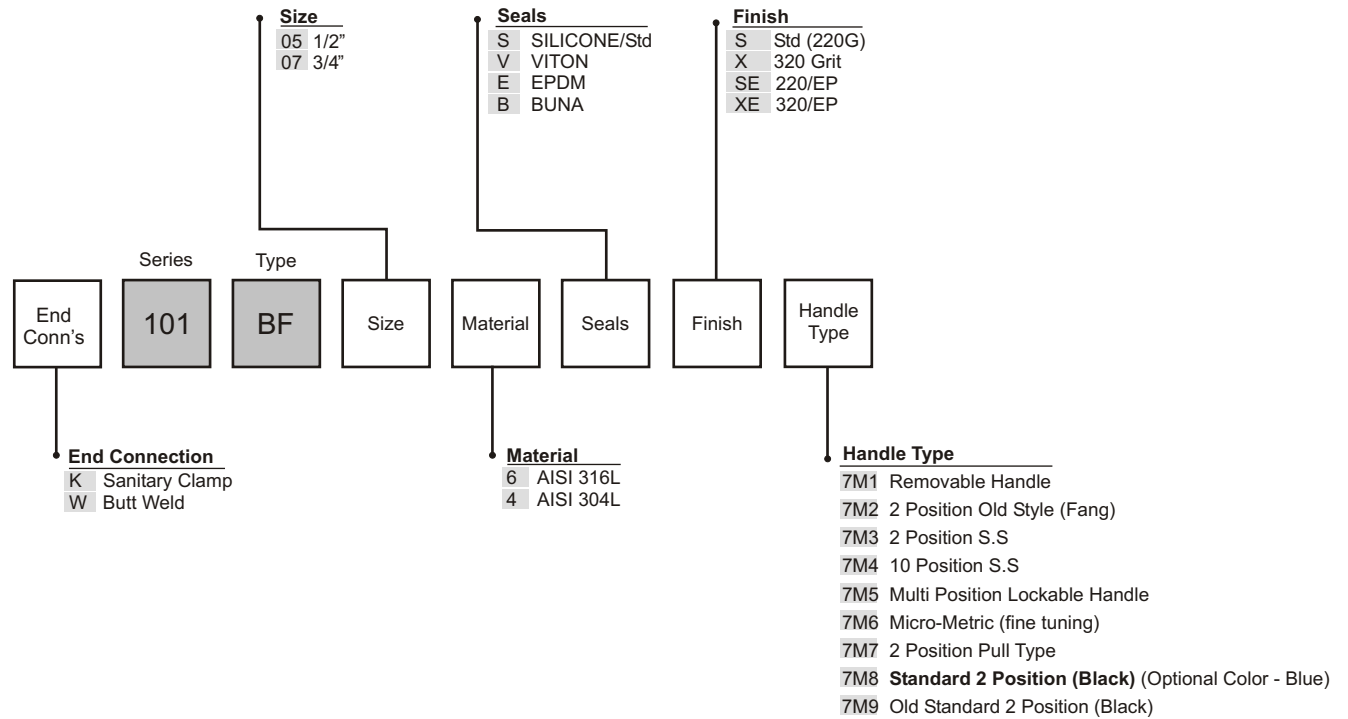

30271 Tomas Street • Rancho Santa Margarita, CA 92688 • Tel. 949/589-3978 • Fax 949/589-3979
Email : cipriani@ciprianicorp.com • Website : <http://www.ciprianicorp.com/>