

SPIRAL WOUND GASKETS

Flexitallic[®]



Introduction

FIRST AND FOREMOST

The concept of spiral wound gasket construction was originated by Flexitallic in 1912, inaugurating the beginning of a new era in safe, effective sealing. The primary purpose for this development was the increasingly severe temperatures and pressures used by U.S. refinery operators in the first half of the century.

The necessity for a gasket to have the ability to recover cannot be over emphasized. The effects of pressure and temperature fluctuations, the temperature differential across the flange face, together with bolt stress relaxation and creep, demand a gasket with adequate flexibility and recovery to maintain a seal even under these varying service conditions. The Flexitallic Spiral Wound Gasket is the precision engineered solution to such problems, meeting the most exacting conditions of both temperature and pressure in flanged joints and similar assemblies and against virtually every known corrosive and toxic media.

This publication is designed to facilitate the specification and ordering of standard Flexitallic Spiral Wound Gaskets. Dimensional data for the basic styles - Style CG, Style CGI, Style R and Style RIR are detailed on respective tables.

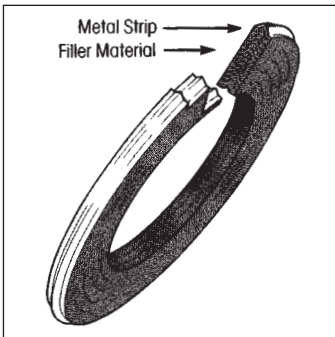

GASKET IDENTIFICATION GUIDE RING COLOR CODING

For ease of identification, Flexitallic Spiral Wound Gaskets utilize a color coding system around the outside edge of the centering ring, thus permitting full identification of both the winding and filler materials.

METALLIC WINDING MATERIALS

The metallic winding material is designated by a solid color identification around the outside edge of the centering ring.

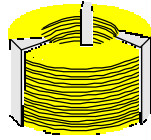

304SS
Yellow

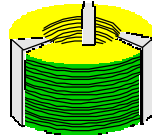

316LSS
Green

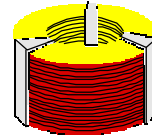

317L
Maroon

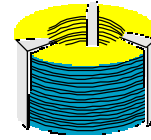

321SS
Turquoise

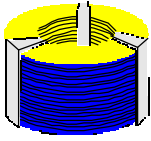

347SS
Blue

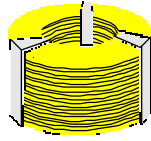

310SS
No color

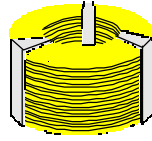

304LSS
No color

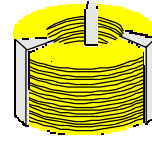

309SS
No color

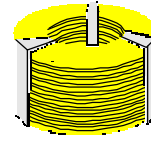

430SS
No color

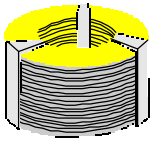

Alloy 20
Black

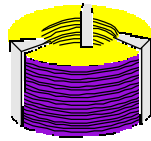

Titanium®
Purple

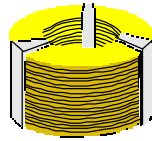

Inconel® 600/625
Gold

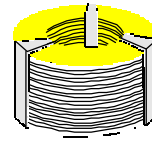

Incoloy® 800/825
White

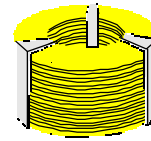

Inconel® X750
No Color

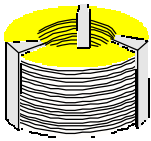

Hastelloy® C276
Beige

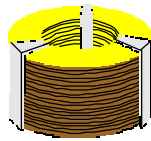

Hastelloy® B2
Brown

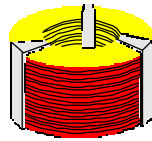

Nickel 200
Red

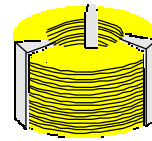

Zirconium
No color

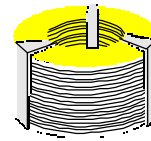

Carbon Steel
Silver

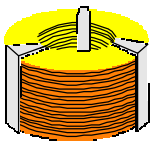

Monel®
Orange

NON METALLIC FILLERS

The gasket filler materials are designated by a number of stripes placed at equal intervals around the outside edge of the centering ring.

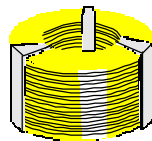

PTFE
White Stripe

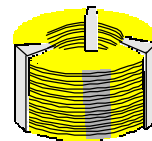

Flexicarb®
Gray Stripe

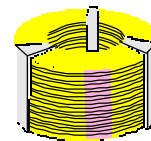

Flexite Super®
Pink Stripe

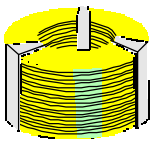

Ceramic
Light Green Stripe

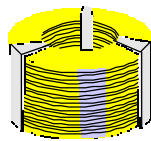

Thermiculite™
Light Blue Stripe

AVAILABLE GASKET MATERIALS

METAL WINDING STRIP	
AS STANDARD	
Stainless Steel	304 type 316L
OTHERS	
Stainless Steel	type 304L 309 310 316Ti 317L 321 347 430 17-7PH
ALLOY 20	
MONEL®	
TITANIUM®	
NICKEL®	200
INCONEL®	600 625 X-750
HASTELLOY®	B2 C276
INCOLOY®	800 825
DUPLEX	
ZIRCONIUM®	
TANTALUM®	
COPPER	
PHOS-BRONZE	
CARBON STEEL	

FILLER MATERIAL	
Flexicarb® flexible graphite	
Thermiculite™	
Flexite Super®	
PTFE	
Mica	
Ceramic	
Non-sintered PTFE	
Thermiculite, FLEXITALLIC'S new high-temperature, sealing material is comprised of chemically exfoliated and thermally exfoliated vermiculite.	
This revolutionary new product simulates the structure of exfoliated graphite but with one notable exception... gaskets made with Thermiculite maintain their integrity, even at extreme temperatures.	
Thermiculite is thermally stable, ensuring against thermal oxidation, at temperatures in excess of 1600°F.	

GUIDE RING MATERIAL	
AS STANDARD	
Carbon Steel	
OTHERS	
Stainless Steel	type 304 304L 316 316L 316Ti 310 321 347 410
INCONEL®	600 625
MONEL®	
TITANIUM®	
NICKEL	
INCOLOY® 800	
ALLOY 20	
INCOLOY®	825
HASTELLOY®	B-2 C276

NOTE
Selected materials should be compatible with operating temperature and chemicals.
If in doubt, contact Flexitallic Technical Department.

PTFE:
If PTFE is subjected to temperatures above 250°C (500°F) decomposition starts to occur slowly, increasing rapidly above 400°C (750°F). Care should be taken to avoid inhaling the resultant fumes, which may produce hazardous effects.

IDENTIFICATION REQUIREMENTS

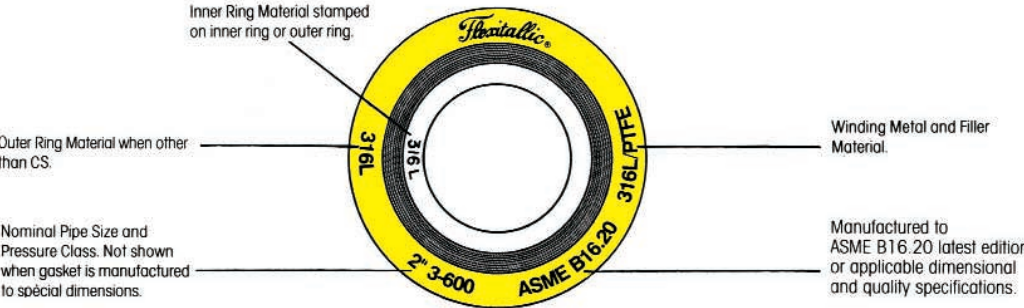

THE ANSWER IS ALWAYS *Flexitallic*®

Style CG

Utilizes an external ring which accurately centers gasket on flange face, provides additional radial strength to prevent gasket blow-out and acts as a compression stop. A general purpose gasket suitable for use with flat face and raised face flanges up to and inclusive of class 2500. Above class 600 an internal ring is recommended.

Style CGI

A Style CG gasket fitted with internal ring which gives an additional compression limiting stop and provides heat and corrosion barrier protecting gasket windings and preventing flange erosion. Suitable for use with flat face and raised face flanges and specified for high pressure/temperature service - class 900 and above or where corrosive or toxic media are present.

Style R

Basic construction type. Inner and outer diameters are reinforced with several plies of metal without filler to give greater stability and better compression and sealing characteristics. Suitable for tongue and groove or male and female or grooved to flat face flange assemblies.

Style RIR

Solid inner metal ring acts as a compression stop and fills the annular space between flange bore and the inside diameter of the gasket. Designed to prevent accumulation of solids, reduce turbulent flow at process turds and minimize erosion at flange faces. Suitable for male and female pipe flanges.

GASKET SELECTION What style of gasket should I select?

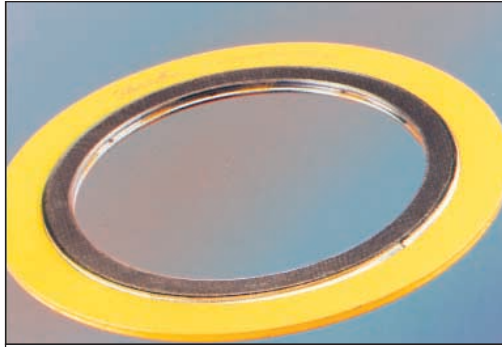

Style CG

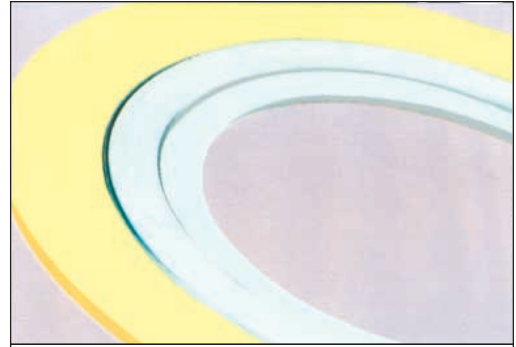

Style CGI



Style R

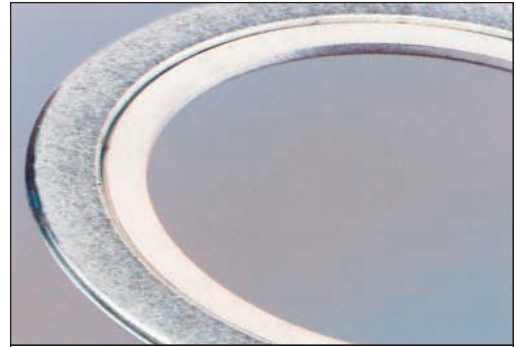

Style RIR

SELECTION GUIDE Published as an indication of which Flexitallic Spiral wound Gasket best suits different pipe flange Configurations and service conditions.

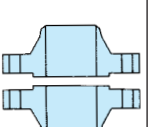
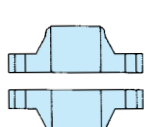
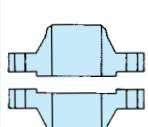
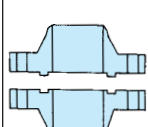
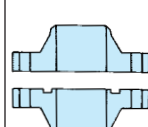
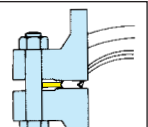
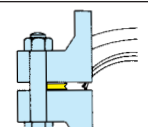
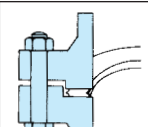
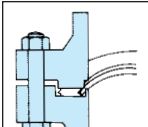
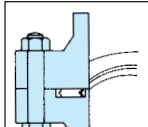
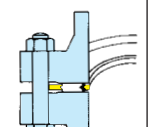
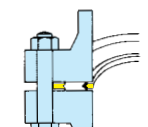
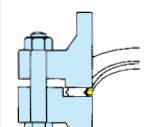
Flange Face	 Raised Face	 Flat Face	 Male and Female	 Tongue and Groove	 Flat Face to Recess
Recommended Gasket Style	 Style CG	 Style CG	 Style R*	 Style R*	 Style R*
Recommended Gasket Style <small>For high pressure/temperature duty, also for gaskets with PTFE filler, corrosive or fluctuating pressure or temperature service conditions.</small>	 Style CGI	 Style CGI	 Style RIR	<p>*NOTE It is essential that Style R gaskets operate with a compression stop. Without a correctly dimensioned stop the gasket can easily be overcompressed resulting in failure. To provide a compression stop the depth of the tongue, groove or recess is controlled to provide optimum compressed gasket thickness with metal to metal contact at the flange faces (see Page 25, Table 16).</p>	

SPECIAL GASKETS

Gaskets of special design can be engineered and fabricated using the same basic fundamentals of Flexitallic Spiral Wound Gasket design and construction to cover a wide range of applications in installations for which there are no industry-wide standards. Special gaskets have been designed for valves, pumps, compressors, turbines, boilers, heat exchangers, etc. Consult with Flexitallic engineers as early in the design stage as possible.

GOVERNMENT SPECIFICATIONS

Flexitallic Spiral Wound Gaskets are available in accordance with Military Specifications MIL-G-24716, and MIL-G-15342, latest revisions. When making an inquiry, refer to the proper Government Specification number.

DIMENSIONAL DATA - STYLE CG & CGI GASKETS
TO SUIT STANDARD RAISED FACE AND FLAT FACE FLANGES

*Style CG

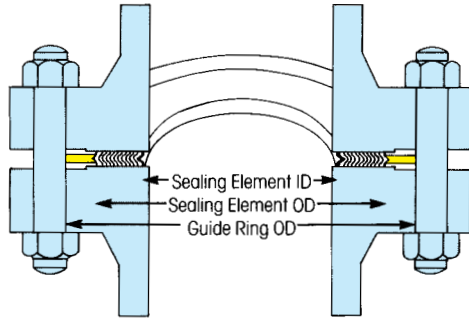

*Style CGI

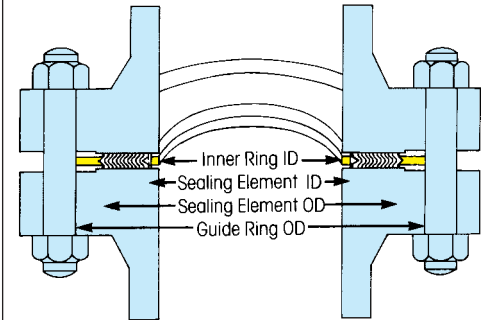

All CG and CGI Gaskets for these standard flanges are 4.5mm (0.175in) thick, fitted with 3.2mm (0.125in) thick solid metal rings. Unless otherwise stated.

Flexitallic style CG and CGI Spiral wound gaskets can be manufactured in accordance with all relevant gasket standards to suit the following flange designations.

ASME	B16.5		
BS	1560		
BS	10		
ASME B16.47	SERIES B	(API 605)	
ASME B16.47	SERIES A	(MSS SP 44)	
BS	4504		
DIN	FLANGES		

Please note that gaskets for non-standard flanges are also readily available.

WHEN ORDERING PLEASE SPECIFY

GASKET STYLE

NOMINAL PIPE SIZE (NPS)

PRESSURE RATING

GASKET STANDARD

WINDING MATERIALS

OUTER RING MATERIAL

INNER RING MATERIAL

EXAMPLE

FLEXITALLIC STYLE "CGI" SPIRAL WOUND GASKET

4"

CLASS 900

ASME B16.20

316L/FLEXICARB

CARBON STEEL

316L

Please select correct gasket style for your particular application. See page 6 "Gasket Selection".

STYLE CG & CGI* TO ASME B16.20 TO SUIT ASME B16.5 FLANGES

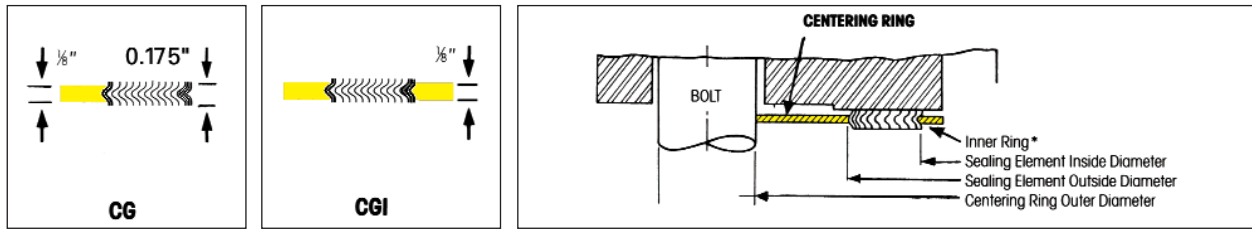

TABLE 1

NOM PIPE SIZE	OUTSIDE DIAMETER OF SEALING ELEMENT		INNER DIAMETER OF SEALING ELEMENT							OUTER DIAMETER OF CENTERING RING						
	CLASS 150, 300, 400, 600	CLASS 900, 1500, 2500	CLASS 150	CLASS 300	CLASS 400	CLASS 600	CLASS 900	CLASS 1500	CLASS 2500	CLASS 150	CLASS 300	CLASS 400	CLASS 600	CLASS 900	CLASS 1500	CLASS 2500
1/4	7/8	-	1/2	1/2	1/2	1/2	-	-	-	1 3/4	1 3/4	1 3/4	1 3/4	-	-	-
1/2	1 1/4	1 1/4	3/4	3/4	3/4	3/4	3/4	3/4	3/4	1 7/8	2 1/8	2 1/8	2 1/8	2 1/2	2 1/2	2 3/4
3/4	1 1/16	1 1/16	1	1	1	1	1	1	1	2 1/4	2 5/8	2 5/8	2 5/8	2 3/4	2 3/4	3
1	1 7/8	1 7/8	1 1/4	1 1/4	1 1/4	1 1/4	1 1/4	1 1/4	1 1/4	2 5/8	2 7/8	2 7/8	2 7/8	3 1/8	3 1/8	3 3/8
1 1/4	2 3/8	2 3/8	1 7/8	1 7/8	1 7/8	1 7/8	1 9/16	1 9/16	1 9/16	3	3 1/4	3 1/4	3 1/4	3 1/2	3 1/2	4 1/8
1 1/2	2 3/4	2 3/4	2 1/8	2 1/8	2 1/8	2 1/8	1 7/8	1 7/8	1 7/8	3 3/8	3 3/4	3 3/4	3 3/4	3 7/8	3 7/8	4 5/8
2	3 3/8	3 3/8	2 3/4	2 3/4	2 3/4	2 3/4	2 5/16	2 5/16	2 5/16	4 1/8	4 3/8	4 3/8	4 3/8	5 5/8	5 5/8	5 3/4
2 1/2	3 7/8	3 7/8	3 1/4	3 1/4	3 1/4	3 1/4	2 3/4	2 3/4	2 3/4	4 7/8	5 1/8	5 1/8	5 1/8	6 1/2	6 1/2	6 5/8
3	4 3/4	4 3/4	4	4	4	4	3 3/4	3 5/8	3 5/8	5 5/8	5 7/8	5 7/8	5 7/8	6 5/8	6 7/8	7 3/4
3 1/2	5 1/4	5 1/4	4 1/2	4 1/2	4 1/8	4 1/8	4 1/8	4 1/8	-	6 3/8	6 1/2	6 3/8	6 3/8	7 1/2	7 3/8	-
4	5 7/8	5 7/8	5	5	4 3/4	4 3/4	4 3/4	4 5/8	4 5/8	6 7/8	7 1/8	7	7 5/8	8 1/8	8 1/4	9 1/4
4 1/2	6 1/2	6 1/2	5 1/2	5 1/2	5 5/16	5 5/16	5 5/16	5 5/16	-	7	7 3/4	7 5/8	8 1/4	9 3/8	9 1/8	-
5	7	7	6 1/8	6 1/8	5 13/16	5 13/16	5 13/16	5 5/8	5 5/8	7 3/4	8 1/2	8 3/8	9 1/2	9 3/4	10	11
6	8 1/4	8 1/4	7 1/16	7 1/16	6 7/8	6 7/8	6 7/8	6 3/4	6 3/4	8 3/4	9 7/8	9 3/4	10 1/2	11 3/8	11 1/8	12 1/2
8	10 3/8	10 3/8	9 3/16	9 3/16	8 7/8	8 7/8	8 3/4	8 1/2	8 1/2	11	12 1/8	12	12 5/8	14 1/8	13 3/8	15 1/4
10	12 1/2	12 1/4	11 5/16	11 5/16	10 13/16	10 13/16	10 7/8	10 1/2	10 5/8	13 3/8	14 1/4	14 1/8	15 3/4	17 1/8	17 1/8	18 3/4
12	14 3/4	14 1/2	13 3/8	13 3/8	12 7/8	12 7/8	12 3/4	12 3/4	12 1/2	16 1/8	16 5/8	16 1/2	18	19 5/8	20 1/2	21 5/8
14	16	15 3/4	14 5/8	14 5/8	14 1/4	14 1/4	14	14 1/4	-	17 3/4	19 1/8	19	19 3/8	20 1/2	22 3/4	-
16	18 1/4	18	16 5/8	16 5/8	16 1/4	16 1/4	16 1/4	16	-	20 1/4	21 1/4	21 1/8	22 1/4	22 5/8	25 1/4	-
18	20 3/4	20 1/2	18 11/16	18 11/16	18 1/2	18 1/2	18 1/4	18 1/4	-	21 5/8	23 1/2	23 3/8	24 1/8	25 1/8	27 3/4	-
20	22 3/4	22 1/2	20 11/16	20 11/16	20 1/2	20 1/2	20 1/2	20 1/4	-	23 7/8	25 3/4	25 1/2	26 7/8	27 1/2	29 3/4	-
24	27	26 3/4	24 3/4	24 3/4	24 3/4	24 3/4	24 3/4	24 1/4	-	28 1/4	30 1/2	30 1/4	31 1/8	33	35 1/2	-

DIMENSIONS IN INCHES.

*For Style CGI - see Table 3 for Inner Ring dimensions

In accordance with ASME B16.20, Inner Rings are mandatory for the following flange designations (see Table 3).

- Class 900 - NPS 24 to 48
- Class 1500 - NPS 12 to NPS 24
- Class 2500 - NPS 4 to NPS 12

ASME B16.20 does not include dimensions for NPS 1/4, 3/8 or 1/2, or Class 400 Flanges up to NPS 3 and Class 900 Flanges up to NPS 2 1/2.

STYLE CG & CGI* TO ASME B16.20 TO SUIT ASME B16.5 FLANGES

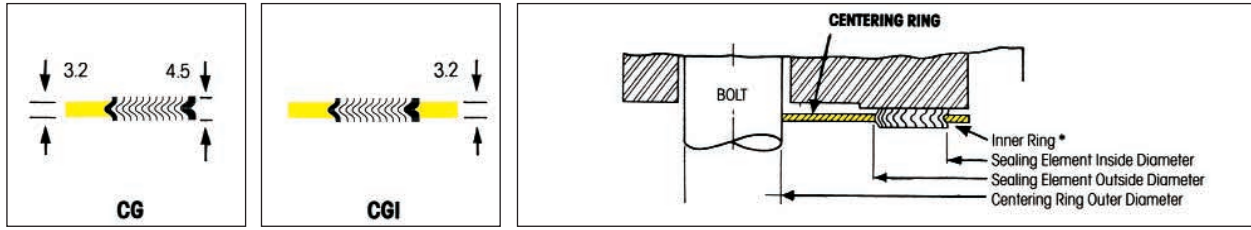

TABLE 2

NOM PIPE SIZE	OUTSIDE DIAMETER OF SEALING ELEMENT		INNER DIAMETER OF SEALING ELEMENT							OUTER DIAMETER OF CENTERING RING						
	CLASS 150, 300, 400, 600	CLASS 900, 1500, 2500	CLASS 150	CLASS 300	CLASS 400	CLASS 600	CLASS 900	CLASS 1500	CLASS 2500	CLASS 150	CLASS 300	CLASS 400	CLASS 600	CLASS 900	CLASS 1500	CLASS 2500
1/4	22.2	-	12.7	12.7	12.7	12.7	-	-	-	44.5	44.5	44.5	44.5	-	-	-
1/2	31.8	31.8	19.1	19.1	19.1	19.1	19.1	19.1	19.1	47.8	54.1	54.1	54.1	63.5	63.5	69.9
3/4	39.6	39.6	25.4	25.4	25.4	25.4	25.4	25.4	25.4	57.2	66.8	66.8	66.8	69.9	69.9	76.2
1	47.8	47.8	31.8	31.8	31.8	31.8	31.8	31.8	31.8	66.8	73.2	73.2	73.2	79.5	79.5	85.9
1 1/4	60.5	60.5	47.8	47.8	47.8	47.8	39.6	39.6	39.6	76.2	82.6	82.6	82.6	88.9	88.9	104.9
1 1/2	69.9	69.9	54.1	54.1	54.1	54.1	47.8	47.8	47.8	85.9	95.3	95.3	95.3	98.6	98.6	117.6
2	85.9	85.9	69.9	69.9	69.9	69.9	58.7	58.7	58.7	104.9	111.3	111.3	111.3	143.0	143.0	146.1
2 1/2	98.6	98.6	82.6	82.6	82.6	82.6	69.9	69.9	69.9	124.0	130.3	130.3	130.3	165.1	165.1	168.4
3	120.7	120.7	101.6	101.6	101.6	101.6	95.3	92.2	92.2	136.7	149.4	149.4	149.4	168.4	174.8	196.9
3 1/2	133.4	133.4	114.3	114.3	104.8	104.8	104.8	104.8	-	161.9	165.1	161.9	161.9	190.5	187.3	-
4	149.4	149.4	127.0	127.0	120.7	120.7	120.7	117.6	117.6	174.8	181.1	177.8	193.8	206.5	209.6	235.0
4 1/2	165.1	165.1	139.7	139.7	134.9	134.9	134.9	134.9	-	177.8	196.9	193.7	209.6	238.1	231.8	-
5	177.8	177.8	155.7	155.7	147.6	147.6	147.6	143.0	143.0	196.9	215.9	212.9	241.3	247.7	254.0	279.4
6	209.6	209.6	182.6	182.6	174.8	174.8	174.8	171.5	171.5	222.3	251.0	247.7	266.7	289.1	282.7	317.5
8	263.7	257.3	233.4	233.4	225.6	225.6	222.3	215.9	215.9	279.4	308.1	304.8	320.8	358.9	352.6	387.4
10	317.5	311.2	287.3	287.3	274.6	274.6	276.4	266.7	270.0	339.9	362.0	358.9	400.1	435.1	435.1	476.3
12	374.7	368.3	339.9	339.9	327.2	327.2	323.9	323.9	317.5	409.7	422.4	419.1	457.2	498.6	520.7	549.4
14	406.4	400.1	371.6	371.6	362.0	362.0	355.6	362.0	-	450.9	485.9	482.6	492.3	520.7	577.9	-
16	463.6	457.2	422.4	422.4	412.8	412.8	412.8	406.4	-	514.4	539.8	536.7	565.2	574.8	641.4	-
18	527.1	520.7	474.7	474.7	469.9	469.9	463.6	463.6	-	549.4	596.9	593.9	612.9	638.3	704.9	-
20	577.9	571.5	525.5	525.5	520.7	520.7	520.7	514.4	-	606.6	654.1	647.7	682.8	698.5	755.7	-
24	685.8	679.5	628.7	628.7	628.7	628.7	628.7	616.0	-	717.6	774.7	768.4	790.7	838.2	901.7	-

DIMENSIONS IN mm.

*For Style CGI - see Table 3 for Inner Ring dimensions

In accordance with ASME B16.20, Inner Rings are mandatory on the following flange designations (see Table 3).

Class 900 - NPS 24 to 48

Class 1500 - NPS 12 to NPS 24

Class 2500 - NPS 4 to NPS 12

ASME B16.20 does not include dimensions for NPS 1/4, 3/2 or 4 1/2, or Class 400 Flanges up to NPS 3 and Class 900 Flanges up to NPS 2 1/2.

STANDARD INSIDE DIAMETERS OF INNER RINGS FOR STYLE CGI GASKETS TO ASME B16.20 TO SUIT ASME B16.5 FLANGES

TABLE
3

NON PIPE SIZE	PRESSURE CLASS													
	150		300		400		600		900		1500		2500	
1/2	0.56	14.22	0.56	14.22	0.56	14.22	0.56	14.22	0.56	14.22	0.56	14.22	0.56	14.22
3/4	0.81	20.57	0.81	20.57	0.81	20.57	0.81	20.57	0.81	20.57	0.81	20.57	0.81	20.57
1	1.06	26.92	1.06	26.92	1.06	26.92	1.06	26.92	1.06	26.92	1.06	26.92	1.06	26.92
1 1/4	1.50	38.10	1.50	38.10	1.50	38.10	1.50	38.10	1.31	33.27	1.31	33.27	1.31	33.27
1 1/2	1.75	44.45	1.75	44.45	1.75	44.45	1.75	44.45	1.63	41.40	1.63	41.40	1.63	41.40
2	2.19	55.63	2.19	55.63	2.19	55.63	2.19	55.63	2.06	52.32	2.06	52.32	2.06	52.52
2 1/2	2.62	66.55	2.62	66.55	2.62	66.55	2.62	66.55	2.50	63.60	2.50	63.50	2.50	63.50
3	3.19	81.03	3.10	78.74	3.10	78.74	3.10	78.74	3.10	78.74	3.10	78.74	3.10	78.74
4	4.19	106.43	4.19	106.43	4.04	102.62	4.04	102.62	4.04	102.62	3.85	97.79	3.85	97.79
5	5.19	131.83	5.19	131.63	5.05	128.27	5.05	128.27	5.05	128.27	4.90	124.46	4.90	124.46
6	6.19	157.23	6.19	157.23	6.10	154.64	6.10	154.94	6.10	154.95	5.80	147.32	5.80	147.32
8	8.50	215.90	8.50	215.90	8.10	205.74	8.10	205.74	7.75	196.85	7.75	196.85	7.75	196.85
10	10.56	288.22	10.56	268.22	10.05	255.27	10.05	255.27	9.69	246.13	9.69	246.13	9.69	246.13
12	12.50	317.50	12.50	317.50	12.10	307.34	12.10	307.34	11.50	292.10	11.50	292.10	11.50	292.10
14	13.75	549.28	13.75	349.25	13.50	342.80	13.50	342.90	12.63	320.80	12.63	320.80	-	-
16	15.75	400.05	15.75	400.05	15.35	389.89	15.35	389.89	14.75	374.65	14.50	388.30	-	-
18	17.69	449.33	17.69	449.33	17.25	438.15	17.25	438.15	16.75	425.45	16.75	425.45	-	-
20	19.69	500.13	19.69	500.13	19.25	488.95	19.25	488.95	19.00	482.60	18.75	476.25	-	-
24	23.75	603.25	23.75	603.25	23.25	590.55	23.25	590.65	23.25	590.55	22.75	577.85	-	-

DIMENSIONS IN INCHES & mm.

STYLE CG & CGI TO SUIT ASME B16.5 & BS 1560 SMALL DIAMETER SCREWED OR SLIP-ON FLANGES

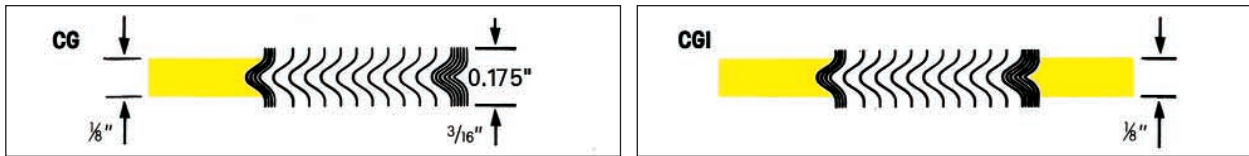

TABLE
4

Nom. Pipe Size	Inner Ring Inside Dia.		Sealing Element				Guide Ring Outside Diameter											
			Inside Dia.	Outside Dia.	Class 150	Class 300	Class 400	Class 600	Class 900	Class 1500								
1/4	-	-	1/16	14.3	7/8	22.2	1 1/4	44.5	1 1/4	44.5	1 3/4	44.5	1 3/4	44.5	-	-	-	-
1/2	1/16	14.3	15/16	23.8	1 1/4	31.8	1 1/8	47.6	2 1/8	54.0	2 1/8	54.0	2 1/8	54.0	2 1/2	63.5	2 1/2	63.5
3/4	13/16	20.6	1 1/16	30.2	1 1/16	39.7	2 1/4	57.2	2 5/8	66.7	2 5/8	66.7	2 5/8	66.7	2 3/4	69.9	2 3/4	69.9
1	1 1/16	27.0	1 1/16	36.5	1 7/8	47.6	2 5/8	66.7	2 7/8	73.0	2 7/8	73.0	2 7/8	73.0	3 1/8	79.4	3 1/8	79.4
1 1/4	1 3/8	34.9	1 7/8	47.6	2 3/8	60.3	3	76.2	3 1/4	82.6	3 1/4	82.6	3 1/4	82.6	3 1/2	88.9	3 1/2	88.9
1 1/2	1 5/8	41.3	2 1/8	54.0	2 3/4	69.9	3 3/8	85.7	3 3/4	95.3	3 3/4	95.3	3 3/4	95.3	3 3/8	98.4	3 3/8	98.4

DIMENSIONS IN INCHES & mm.

NOTE: The above style CG & CGI spiral wound gaskets are dimensioned to suit existing screwed or slip-on flanges for NPS 1/4 to 1 1/2 ASME B16.5 & BS 1560 flanges.

MAXIMUM BORE OF ASME B16.5 FLANGES

FOR USE WITH STYLE CG & CGI SPIRAL WOUND GASKETS

This table shows the maximum bore of flanges for which the spiral-wound gasket dimensions shown are recommended considering the tolerances involved, possible eccentric installation, and the possibility that the gasket may extend into the assembled flange bore.

TABLE
5

FLANGE SIZE (NPS)	PRESSURE CLASS										
	75	150	300	400	600	900	1500*	2500*			
1/2	No flanges	WN flange only ^b	No flanges Use Class 600	WN flange only ^b	No flanges Use Class 1500	WN flange only ^b	WN flange only ^b	WN flange only ^b			
3/4											
1											
1 1/4		SO flange ^c WN flange ^b		SO flange ^c WN flange, any bore							
1 1/2											
2		SO flange ^c WN flange, any bore ^b		SO flange ^c WN flange, any bore							
2 1/2											
3		SO flange WN flange, any bore		SO flange ^c WN flange, any bore	WN flange with Schedule 10S bore described in ASME B36.19M (includes nozzle ^d but excludes SO flange)				No flanges	WN flange with Schedule 80 bore (excludes nozzle and SO flange)	WN flange with SW bore (includes nozzle ^d but excludes SO flange)
4											
6				WN flange with Schedule 10S bore described in ASME B36.19M (excludes nozzle ^d and SO flange) ^e	No flanges				WN flange with Schedule 80 bore (excludes nozzle and SO flange)	No flanges	No flanges
8											
10											
12											
14											
16											
18	No flanges										
20											
24											

Note: SO = slip on and threaded; WN = welding neck; SW = standard wall.

^aInner rings are required for Class 900 gaskets, NPS 24; Class 1500 gaskets, NPS 12 through NPS 24; and Class 2500 gaskets; NPS 4 through NPS 12. These inner rings may extend into the pipe bore a maximum of 0.06 inch (1.5 millimeters) under the worst combination of maximum bore, eccentric installation, and additive tolerances.

^bIn these sizes the gasket is suitable for welding-neck flange with a standard-wall bore, if the gasket and the flanges are assembled concentrically. This also applies to nozzle. It is the user's responsibility to determine if the gasket is satisfactory for a flange of any larger bore.

^cGaskets in these sizes are suitable for slip-on flanges only if the gaskets and flanges are assembled concentrically.

^dA nozzle is a long welding neck; the bore equals the flange NPS.

^eAn NPS 24 gasket is suitable for nozzles.

*Spiral wound gasket dimensions for use on screwed or slip-on flanges – see Table 4.

STYLE CG & CGI TO ASME B16.20
TO SUIT LARGE DIAMETER ASME B16.47 SERIES B FLANGES
CLASS 75-300

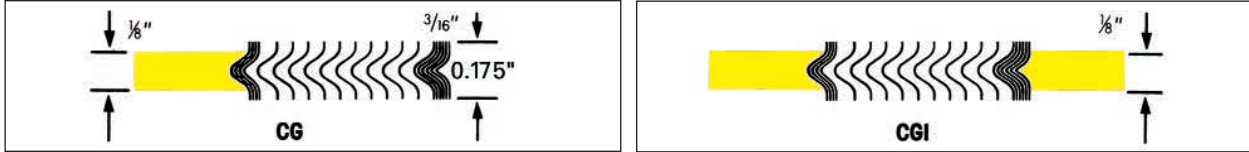

TABLE 6

Nom. Pipe Size	CLASS 75		
	Sealing Element		Centering Ring Outside Dia.
	Inside Dia.	Outside Dia.	
26	26 ¹ / ₄	27	27 ⁷ / ₈
28	28 ¹ / ₄	29 ¹ / ₈	29 ⁷ / ₈
30	30 ¹ / ₄	31 ¹ / ₈	31 ⁷ / ₈
32	32 ¹ / ₄	33 ¹ / ₈	33 ⁷ / ₈
34	34 ¹ / ₄	35 ¹ / ₈	35 ⁷ / ₈
36	36 ¹ / ₄	37 ¹ / ₄	38 ⁹ / ₁₆
38	-	-	-
40	-	-	-
42	42 ¹ / ₄	43 ³ / ₄	44 ⁵ / ₁₆
44	-	-	-
46	-	-	-
48	48 ³ / ₈	49 ¹ / ₂	50 ¹ / ₂
50	-	-	-
52	-	-	-
54	54 ³ / ₈	55 ⁵ / ₈	56 ⁵ / ₈
56	--	-	-
58	-	-	-
60	60 ¹ / ₂	61 ³ / ₄	62 ⁷ / ₈

Nom. Pipe Size	Inner Ring Inside Dia.	Sealing Element		Centering Ring Outside Dia.
		Inside Dia.	Outside Dia.	
		26	25 ³ / ₄	
28	27 ³ / ₄	28 ¹ / ₂	29 ¹ / ₂	30 ⁹ / ₁₆
30	29 ³ / ₄	30 ¹ / ₂	31 ¹ / ₂	32 ⁹ / ₁₆
32	31 ³ / ₄	32 ¹ / ₂	33 ¹ / ₂	34 ¹¹ / ₁₆
34	33 ³ / ₄	34 ¹ / ₂	35 ³ / ₄	36 ¹³ / ₁₆
36	35 ³ / ₄	36 ¹ / ₂	37 ³ / ₄	38 ⁷ / ₈
38	37 ³ / ₄	38 ³ / ₈	39 ³ / ₄	41 ¹ / ₈
40	39 ³ / ₄	40 ¹ / ₄	41 ⁷ / ₈	43 ³ / ₈
42	41 ³ / ₄	42 ¹ / ₂	43 ³ / ₈	45 ¹ / ₈
44	43 ³ / ₄	44 ¹ / ₄	45 ⁵ / ₈	47 ¹ / ₈
46	45 ³ / ₄	46 ¹ / ₂	48 ³ / ₁₆	49 ⁷ / ₁₆
48	47 ³ / ₄	48 ¹ / ₂	50	51 ¹ / ₁₆
50	49 ³ / ₄	50 ¹ / ₂	52 ² / ₁₆	53 ⁷ / ₁₆
52	51 ³ / ₄	52 ¹ / ₂	54 ³ / ₁₆	55 ⁷ / ₁₆
54	53 ³ / ₄	54 ¹ / ₂	56	57 ⁵ / ₈
56	56	56 ⁷ / ₈	58 ³ / ₁₆	59 ⁵ / ₈
58	58 ⁷ / ₁₆	59 ¹ / ₁₆	60 ³ / ₁₆	62 ³ / ₁₆
60	60 ⁷ / ₁₆	61 ⁵ / ₁₆	62 ⁷ / ₁₆	64 ³ / ₁₆

Nom. Pipe Size	Inner Ring Inside Dia.	Sealing Element		Centering Ring Outside Dia.
		Inside Dia.	Outside Dia.	
		26	25 ³ / ₄	
28	27 ³ / ₄	28 ¹ / ₂	30	32 ¹ / ₂
30	29 ³ / ₄	30 ¹ / ₂	32	34 ⁷ / ₈
32	31 ³ / ₄	32 ¹ / ₂	34	37
34	33 ³ / ₄	34 ¹ / ₂	36	39 ¹ / ₈
36	35 ³ / ₄	36 ¹ / ₂	38	41 ¹ / ₄
38	38 ¹ / ₄	39 ³ / ₄	41 ¹ / ₄	43 ¹ / ₄
40	40 ¹ / ₄	41 ³ / ₄	43 ¹ / ₄	45 ¹ / ₄
42	42 ³ / ₄	43 ³ / ₄	45 ¹ / ₄	47 ¹ / ₄
44	44 ¹ / ₄	45 ³ / ₄	47 ¹ / ₄	49 ¹ / ₄
46	46 ³ / ₈	47 ⁷ / ₈	49 ³ / ₈	51 ¹ / ₈
48	48 ¹ / ₂	49 ³ / ₄	51 ⁵ / ₈	53 ³ / ₈
50	49 ⁷ / ₈	51 ¹ / ₈	53 ³ / ₈	55 ⁷ / ₈
52	51 ¹ / ₈	53 ³ / ₈	55 ³ / ₈	57 ⁷ / ₈
54	53 ³ / ₄	55 ¹ / ₄	57 ¹ / ₄	60 ¹ / ₄
56	56 ¹ / ₄	58 ¹ / ₄	60	62 ³ / ₄
58	58 ⁷ / ₁₆	60 ⁷ / ₁₆	61 ¹⁵ / ₁₆	65 ³ / ₁₆
60	61 ⁵ / ₁₆	62 ⁹ / ₁₆	64 ³ / ₁₆	67 ³ / ₁₆

DIMENSIONS IN INCHES.

NOTE: Gasket dimensions to suit Class 75 flanges are not specified in ASME B16.20. These gaskets have been dimensioned to suit the flanges.

STYLE CG & CGI TO ASME B16.20
TO SUIT LARGE DIAMETER ASME B16.47 SERIES B FLANGES
CLASS 400-900



TABLE 6.1

CLASS 400					CLASS 600					CLASS 900*				
Nom. Pipe Size	Inner Ring Inside Dia.	Sealing Element		Centering Ring Outside Dia.	Nom. Pipe Size	Inner Ring Inside Dia.	Sealing Element		Centering Ring Outside Dia.	Nom. Pipe Size	Inner Ring Inside Dia.	Sealing Element		Centering Ring Outside Dia.
		Inside Dia.	Outside Dia.				Inside Dia.	Outside Dia.				Inside Dia.	Outside Dia.	
26	25 ³ / ₄	26 ¹ / ₄	27 ¹ / ₂	29 ³ / ₈	26	25 ³ / ₈	26 ¹ / ₈	28 ¹ / ₈	30 ¹ / ₈	26	26 ¹ / ₄	27 ¹ / ₄	29 ¹ / ₂	33
28	27 ⁵ / ₈	28 ¹ / ₈	29 ¹ / ₂	31 ¹ / ₂	28	27	27 ³ / ₄	29 ³ / ₄	32 ¹ / ₄	28	28 ¹ / ₄	29 ¹ / ₄	31 ¹ / ₂	35 ¹ / ₂
30	29 ⁵ / ₈	30 ¹ / ₈	31 ³ / ₄	33 ³ / ₄	30	29 ⁵ / ₈	30 ⁵ / ₈	32 ⁵ / ₈	34 ⁵ / ₈	30	30 ³ / ₄	31 ³ / ₄	33 ³ / ₄	37 ³ / ₄
32	31 ¹ / ₂	32	33 ⁷ / ₈	35 ⁷ / ₈	32	31 ¹ / ₄	32 ³ / ₄	34 ³ / ₄	36 ³ / ₄	32	33	34	36	40
34	33 ¹ / ₂	34 ¹ / ₈	35 ⁷ / ₈	37 ⁷ / ₈	34	33 ¹ / ₂	35	37	39 ¹ / ₄	34	35 ¹ / ₄	36 ¹ / ₄	38 ¹ / ₄	42 ¹ / ₄
36	35 ³ / ₈	36 ¹ / ₈	38	40 ¹ / ₄	36	35 ¹ / ₂	37	39	41 ¹ / ₄	36	36 ¹ / ₄	37 ¹ / ₄	39 ¹ / ₄	44 ¹ / ₄
38	37 ¹ / ₂	38 ¹ / ₄	40 ¹ / ₄	42 ¹ / ₄	38	37 ¹ / ₂	39	41	43 ¹ / ₂	38	39 ³ / ₄	40 ³ / ₄	42 ³ / ₄	47 ¹ / ₄
40	39 ³ / ₈	40 ³ / ₈	42 ³ / ₈	44 ³ / ₈	40	39 ³ / ₄	41 ¹ / ₄	43 ¹ / ₄	45 ¹ / ₂	40	41 ³ / ₄	43 ³ / ₄	45 ³ / ₄	49 ¹ / ₄
42	41 ³ / ₈	42 ³ / ₈	44 ³ / ₈	46 ³ / ₈	42	42	43 ¹ / ₂	45 ¹ / ₂	48	42	43 ³ / ₄	45 ³ / ₄	47 ³ / ₄	51 ¹ / ₄
44	43 ¹ / ₂	44 ¹ / ₂	46 ¹ / ₂	48 ¹ / ₂	44	43 ³ / ₄	45 ³ / ₄	47 ³ / ₄	50	44	45 ¹ / ₂	47 ¹ / ₂	49 ¹ / ₂	53 ⁷ / ₈
46	46	47	49	50 ³ / ₄	46	45 ³ / ₄	47 ³ / ₄	49 ³ / ₄	52 ¹ / ₄	46	48	50	52	56 ¹ / ₂
48	47 ¹ / ₂	49	51	53	48	48	50	52	54 ³ / ₄	48	50	52	54	58 ¹ / ₂
50	49 ¹ / ₂	51	53	55 ¹ / ₄	50	50	52	54	57	50	-	-	-	-
52	51 ¹ / ₂	53	55	57 ¹ / ₄	52	52	54	56	59	52	-	-	-	-
54	53 ¹ / ₄	55 ¹ / ₄	57 ¹ / ₄	59 ³ / ₄	54	54 ¹ / ₄	56 ¹ / ₄	58 ¹ / ₄	61 ¹ / ₄	54	-	-	-	-
56	55 ¹ / ₄	57 ¹ / ₄	59 ¹ / ₄	61 ³ / ₄	56	56 ¹ / ₄	58 ¹ / ₄	60 ¹ / ₄	63 ¹ / ₂	56	-	-	-	-
58	57 ¹ / ₄	59 ¹ / ₄	61 ¹ / ₄	63 ³ / ₄	58	58	60 ¹ / ₂	62 ¹ / ₂	65 ¹ / ₂	58	-	-	-	-
60	59 ¹ / ₄	61 ³ / ₄	63 ³ / ₄	66 ¹ / ₄	60	60 ¹ / ₄	62 ³ / ₄	64 ³ / ₄	68 ¹ / ₄	60	-	-	-	-

DIMENSIONS IN INCHES.

NOTE: There are no class 900 flanges NPS 50 and larger.
 *Inner rings are mandatory for class 900 flanges, NPS 26 to 48.

STYLE CG & CGI TO ASME B16.20
TO SUIT LARGE DIAMETER ASME B16.47 SERIES A FLANGES
CLASS 150-300

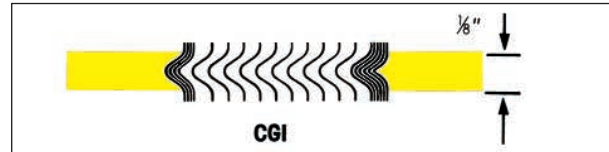
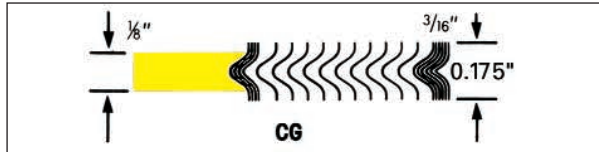

TABLE 7

CLASS 150				
Nom. Pipe Size	Inner Ring Inside Dia.	Sealing Element		Centering Ring Outside Dia.
		Inside Dia.	Outside Dia.	
22	—	22 ³ / ₄	24	26
26	25 ³ / ₄	26 ¹ / ₂	27 ³ / ₄	30 ¹ / ₂
28	27 ³ / ₄	28 ¹ / ₂	29 ³ / ₄	32 ³ / ₄
30	29 ³ / ₄	30 ¹ / ₂	31 ³ / ₄	34 ³ / ₄
32	31 ³ / ₄	32 ¹ / ₂	33 ⁷ / ₈	37
34	33 ³ / ₄	34 ¹ / ₂	35 ⁷ / ₈	39
36	35 ³ / ₄	36 ¹ / ₂	38 ¹ / ₈	41 ¹ / ₄
38	37 ³ / ₄	38 ¹ / ₂	40 ¹ / ₈	43 ³ / ₄
40	39 ³ / ₄	40 ¹ / ₂	42 ¹ / ₈	45 ³ / ₄
42	41 ³ / ₄	42 ¹ / ₂	44 ¹ / ₄	48
44	43 ³ / ₄	44 ¹ / ₂	46 ³ / ₈	50 ¹ / ₄
46	45 ³ / ₄	46 ¹ / ₂	48 ³ / ₈	52 ¹ / ₄
48	47 ³ / ₄	48 ¹ / ₂	50 ³ / ₈	54 ¹ / ₂
50	49 ³ / ₄	50 ¹ / ₂	52 ¹ / ₂	56 ¹ / ₂
52	51 ³ / ₄	52 ¹ / ₂	54 ¹ / ₂	58 ³ / ₄
54	53 ¹ / ₂	54 ¹ / ₂	56 ¹ / ₂	61
56	55 ¹ / ₂	56 ¹ / ₂	58 ¹ / ₂	63 ¹ / ₄
58	57 ¹ / ₂	58 ¹ / ₂	60 ¹ / ₂	65 ¹ / ₂
60	59 ¹ / ₂	60 ¹ / ₂	62 ¹ / ₂	67 ¹ / ₂

CLASS 300				
Nom. Pipe Size	Inner Ring Inside Dia.	Sealing Element		Centering Ring Outside Dia.
		Inside Dia.	Outside Dia.	
22	—	22 ³ / ₄	24 ³ / ₄	27 ³ / ₄
26	25 ³ / ₄	27	29	32 ⁷ / ₈
28	27 ³ / ₄	29	31	35 ³ / ₈
30	29 ³ / ₄	31 ¹ / ₄	33 ¹ / ₄	37 ¹ / ₂
32	31 ³ / ₄	33 ¹ / ₂	35 ¹ / ₂	39 ⁵ / ₈
34	33 ³ / ₄	35 ¹ / ₂	37 ¹ / ₂	41 ⁵ / ₈
36	35 ³ / ₄	37 ³ / ₈	39 ³ / ₈	44
38	37 ¹ / ₂	38 ¹ / ₂	40	41 ¹ / ₂
40	39 ¹ / ₂	40 ¹ / ₄	42 ¹ / ₈	43 ⁷ / ₈
42	41 ¹ / ₂	42 ¹ / ₄	44 ¹ / ₈	45 ⁷ / ₈
44	43 ¹ / ₂	44 ¹ / ₂	46 ¹ / ₂	48
46	45 ⁵ / ₈	46 ³ / ₈	48 ³ / ₈	50 ⁵ / ₈
48	47 ⁵ / ₈	48 ⁵ / ₈	50 ⁵ / ₈	52 ⁵ / ₈
50	49	51	53	54 ¹ / ₄
52	52	53	55	56 ¹ / ₄
54	53 ¹ / ₄	55 ¹ / ₄	57 ¹ / ₄	58 ³ / ₄
56	55 ¹ / ₄	57 ¹ / ₄	59 ¹ / ₄	60 ³ / ₄
58	57	59 ¹ / ₂	61 ¹ / ₂	62 ³ / ₄
60	60	61 ¹ / ₂	63 ¹ / ₂	64 ³ / ₄

DIMENSIONS IN INCHES.

The above style CG gasket dimensions are also suitable for NPS 26 to 48 class 150 and NPS 26 to 36 class 300 BS 3293 flanges.

STYLE CG & CGI TO ASME B16.20 TO SUIT LARGE DIAMETER ASME B16.47 SERIES A FLANGES CLASS 400-600-900



TABLE 7.1

Nom. Pipe Size	CLASS 400				CLASS 600				CLASS 900*					
	Inner Ring Inside Dia.	Sealing Element		Centering Ring Outside Dia.	Inner Ring Inside Dia.	Sealing Element		Centering Ring Outside Dia.	Inner Ring Inside Dia.	Sealing Element		Centering Ring Outside Dia.		
		Inside Dia.	Outside Dia.			Inside Dia.	Outside Dia.			Inside Dia.	Outside Dia.			
22	-	22 ³ / ₄	24 ³ / ₄	27 ⁵ / ₈	22	-	22 ³ / ₄	24 ³ / ₄	28 ⁷ / ₈	22	-	-	-	
26	26	27	29	32 ³ / ₄	26	25 ¹ / ₂	27	29	34 ¹ / ₈	26	26	27	29	34 ³ / ₄
28	28	29	31	35 ¹ / ₈	28	27 ¹ / ₂	29	31	36	28	28	29	31	37 ¹ / ₄
30	29 ³ / ₄	31 ¹ / ₄	33 ³ / ₄	37 ¹ / ₄	30	29 ³ / ₄	31 ¹ / ₄	33 ³ / ₄	38 ¹ / ₄	30	30 ¹ / ₄	31 ¹ / ₄	33 ³ / ₄	39 ³ / ₄
32	32	33 ¹ / ₂	35 ¹ / ₂	39 ¹ / ₂	32	32	33 ¹ / ₂	35 ¹ / ₂	40 ¹ / ₄	32	32	33 ¹ / ₂	35 ¹ / ₂	42 ¹ / ₄
34	34	35 ¹ / ₂	37 ¹ / ₂	41 ¹ / ₂	34	34	35 ¹ / ₂	37 ¹ / ₂	42 ¹ / ₄	34	34	35 ¹ / ₂	37 ¹ / ₂	44 ³ / ₄
36	36 ¹ / ₈	37 ⁵ / ₈	39 ⁵ / ₈	44	36	36 ¹ / ₈	37 ⁵ / ₈	39 ⁵ / ₈	44 ¹ / ₂	36	36 ¹ / ₄	37 ³ / ₄	39 ³ / ₄	47 ¹ / ₄
38	37 ¹ / ₂	38 ¹ / ₄	40 ¹ / ₄	42 ¹ / ₄	38	37 ¹ / ₂	39	41	43 ¹ / ₂	38	39 ³ / ₄	40 ³ / ₄	42 ³ / ₄	47 ¹ / ₄
40	39 ³ / ₈	40 ³ / ₈	42 ³ / ₈	44 ³ / ₈	40	39 ³ / ₄	41 ¹ / ₄	43 ¹ / ₄	45 ¹ / ₂	40	41 ³ / ₄	43 ¹ / ₄	45 ¹ / ₄	49 ¹ / ₄
42	41 ³ / ₈	42 ³ / ₈	44 ³ / ₈	46 ³ / ₈	42	42	43 ¹ / ₂	45 ¹ / ₂	48	42	43 ³ / ₄	45 ¹ / ₄	47 ¹ / ₄	51 ¹ / ₄
44	43 ¹ / ₂	44 ¹ / ₂	46 ¹ / ₂	48 ¹ / ₂	44	43 ³ / ₄	45 ³ / ₄	47 ³ / ₄	50	44	45 ¹ / ₂	47 ¹ / ₂	49 ¹ / ₂	53 ³ / ₈
46	46	47	49	50 ³ / ₄	46	45 ³ / ₄	47 ³ / ₄	49 ³ / ₄	52 ¹ / ₄	46	48	50	52	56 ¹ / ₂
48	47 ¹ / ₂	49	51	53	48	48	50	52	54 ³ / ₄	48	50	52	54	58 ¹ / ₂
50	49 ¹ / ₂	51	53	55 ¹ / ₄	50	50	52	54	57	50	-	-	-	-
52	51 ¹ / ₂	53	55	57 ¹ / ₄	52	52	54	56	59	52	-	-	-	-
54	53 ¹ / ₄	55 ¹ / ₄	57 ¹ / ₄	59 ³ / ₄	54	54 ¹ / ₄	56 ¹ / ₄	58 ¹ / ₄	61 ¹ / ₄	54	-	-	-	-
56	55 ¹ / ₄	57 ¹ / ₄	59 ¹ / ₄	61 ³ / ₄	56	56 ¹ / ₄	58 ¹ / ₄	60 ¹ / ₄	63 ¹ / ₂	56	-	-	-	-
58	57 ¹ / ₄	59 ¹ / ₄	61 ¹ / ₄	63 ³ / ₄	58	58	60 ¹ / ₂	62 ¹ / ₂	65 ¹ / ₂	58	-	-	-	-
60	59 ³ / ₄	61 ³ / ₄	63 ³ / ₄	66 ¹ / ₄	60	60 ¹ / ₄	62 ³ / ₄	64 ³ / ₄	68 ¹ / ₄	60	-	-	-	-

DIMENSIONS IN INCHES.

NOTE: There are no class 900 flanges NPS 50 and larger.

*Inner rings are mandatory for class 900 flanges, NPS 26 to 48.

For ASME B16.47 Series A flanges NPS 12 to 24 use gasket dimensions listed on page 10, for ASME B 16.5 flanges.

The above style CG gasket dimensions are also suitable for NPS 26 to 36 class 400 and 600 BS 3293 flanges.

STYLE CG & CGI TO SUIT LARGE DIAMETER FLANGES CLASS 75-125

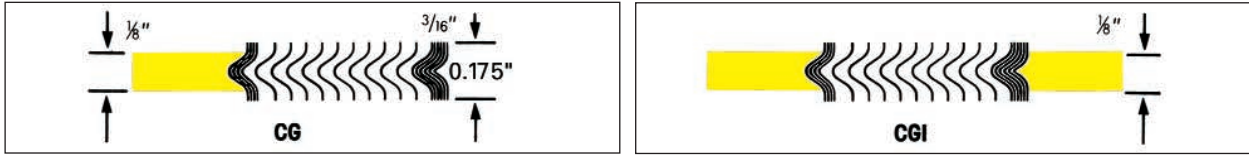

TABLE 8

CLASS 75 - SLIP-ON AND BLIND†				CLASS 75 - WELD-NECK AND BLIND†				CLASS 125			
Nom. Pipe Size	Sealing Element		Centering Ring Outside Dia.	Nom. Pipe Size	Sealing Element		Centering Ring Outside Dia.	Nom. Pipe Size	Sealing Element		Centering Ring Outside Dia.
	Inside Dia.	Outside Dia.			Inside Dia.	Outside Dia.			Inside Dia.	Outside Dia.	
26	27	28 ¹ / ₄	30 ¹ / ₈	26	26 ¹ / ₂	27 ³ / ₄	28 ³ / ₄	26	26 ¹ / ₂	27 ³ / ₄	30 ¹ / ₂
28	29	30 ¹ / ₄	32 ¹ / ₈	28	28 ¹ / ₂	29 ³ / ₄	30 ³ / ₄	28	28 ¹ / ₂	29 ³ / ₄	32 ³ / ₄
30	31	32 ¹ / ₄	34 ¹ / ₈	30	30 ¹ / ₂	31 ³ / ₄	32 ³ / ₄	30	30 ¹ / ₂	31 ³ / ₄	34 ³ / ₄
32	33 ³ / ₈	34 ³ / ₈	36 ³ / ₈	32	32 ¹ / ₂	33 ³ / ₄	35 ¹ / ₈	32	32 ¹ / ₂	33 ³ / ₈	37
34	35 ¹ / ₈	36 ¹ / ₂	38 ³ / ₈	34	34 ¹ / ₂	35 ⁷ / ₈	37 ¹ / ₈	34	34 ¹ / ₂	35 ⁵ / ₈	39
36	37 ¹ / ₈	38 ¹ / ₂	40 ³ / ₈	36	36 ¹ / ₂	37 ⁷ / ₈	39 ¹ / ₈	36	36 ¹ / ₂	38 ¹ / ₈	41 ¹ / ₄
38	-	-	-	38	-	-	-	38	38 ¹ / ₂	40 ¹ / ₈	43 ³ / ₄
40	-	-	-	40	-	-	-	40	40 ¹ / ₂	42 ¹ / ₈	45 ³ / ₄
42	43 ¹ / ₄	44 ³ / ₄	46 ⁵ / ₈	42	42 ¹ / ₂	44	45 ⁵ / ₈	42	42 ¹ / ₂	44 ¹ / ₄	48
44	-	-	-	44	-	-	-	44	44 ¹ / ₂	46 ³ / ₈	50 ¹ / ₄
46	-	-	-	46	-	-	-	46	46 ¹ / ₂	48 ³ / ₈	52 ¹ / ₄
48	49 ¹ / ₄	50 ⁵ / ₈	52 ⁵ / ₈	48	48 ¹ / ₂	50 ⁵ / ₈	51 ⁵ / ₈	48	48 ¹ / ₂	50 ³ / ₈	54 ¹ / ₂
50	-	-	-	50	-	-	-	50	50 ¹ / ₂	52 ¹ / ₂	56 ¹ / ₂
52	-	-	-	52	-	-	-	52	52 ¹ / ₂	54 ¹ / ₂	58 ³ / ₄
54	55 ³ / ₈	57 ³ / ₄	59 ¹ / ₈	54	54 ¹ / ₂	56 ³ / ₈	57 ¹ / ₈	54	54 ¹ / ₄	56 ¹ / ₂	61
60	61 ³ / ₈	63 ³ / ₈	65 ¹ / ₈	60	60 ¹ / ₂	62 ¹ / ₂	63 ¹ / ₈	60	60 ¹ / ₂	62 ¹ / ₂	67 ¹ / ₂
66	67 ¹ / ₂	69 ¹ / ₂	71 ³ / ₄	66	66 ¹ / ₂	68 ¹ / ₂	70 ¹ / ₄	66	71	72 ³ / ₄	74 ¹ / ₄
72	73 ¹ / ₂	75 ¹ / ₂	77 ³ / ₄	72	72 ¹ / ₂	74 ¹ / ₂	76 ¹ / ₄	72	77 ¹ / ₂	79 ¹ / ₄	80 ³ / ₄
84	-	-	-	84	-	-	-	84	90 ¹ / ₄	92	93 ¹ / ₂
96	-	-	-	96	-	-	-	96	103	104 ³ / ₄	106 ¹ / ₄

DIMENSIONS IN INCHES.

GASKET THICKNESS. TO ENSURE GREATER GASKET STABILITY; FOR LARGER DIAMETER ABOVE 39" (1000 mm) WE RECOMMEND 7.2 mm (0.285 in) THICK GASKETS WITH 5.0 mm (0.197 in) THICK GUIDE RINGS, OR 6.4 mm (0.250 in) THICK GASKETS WITH 4.8 mm (0.188 in) THICK GUIDE RINGS.

†OUTSIDE DIAMETER, FACING DIAMETER AND DRILLING OF CLASS 75 BLIND FLANGES DEPEND ON WHETHER THEY ARE TO BE USED AGAINST WELD-NECK OR SLIP-ON FLANGES.

*WHERE STYLE CGI GASKETS ARE REQUIRED, INNER RING I.D. MUST BE SPECIFIED. STANDARD PRACTICE IS TO USE INNER RINGS WITH AN I.D. THAT IS 3.2 mm (0.125 in.) GREATER THAN THE FLANGE BORE.

STYLE CG & CGI TO SUIT LARGE DIAMETER FLANGES CLASS 175-350

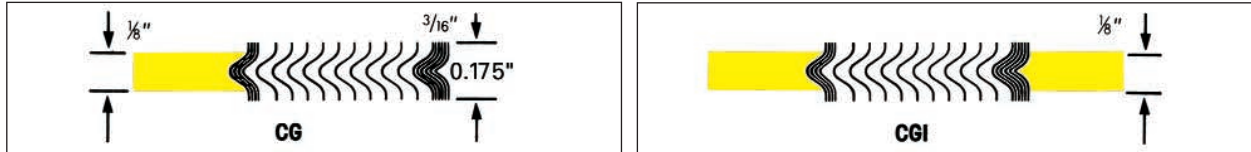

TABLE 8.1

CLASS 175				CLASS 250				CLASS 350			
Nom. Pipe Size	Sealing Element		Centering Ring Outside Dia.	Nom. Pipe Size	Sealing Element		Centering Ring Outside Dia.	Nom. Pipe Size	Sealing Element		Centering Ring Outside Dia.
	Inside Dia.	Outside Dia.			Inside Dia.	Outside Dia.			Inside Dia.	Outside Dia.	
26	26½	27¾	29⅞	26	26½	27¾	32¾	26	26½	27¾	29⅝
28	28½	29¾	31⅞	28	28½	29¾	35¼	28	28½	29¾	31⅝
30	30½	31¾	33⅞	30	30½	31¾	37½	30	30½	31¾	33⅞
32	32½	33¾	35⅞	32	32½	33¾	39¾	32	32½	33¾	35⅞
34	34½	35⅞	37½	34	34½	35⅞	41¾	34	34½	35⅞	37⅞
36	36½	37⅞	39½	36	36½	38⅞	44	36	36½	38⅞	40⅞
38	38½	39⅞	41½	38	38½	40⅞	46	38	38½	40⅞	42⅞
40	40½	42	43½	40	40½	42⅞	48¼	40	40½	42⅞	44⅞
42	42½	44	45⅞	42	42½	44¼	50¾	42	42½	44¼	46⅞
44	44½	46	47⅞	44	44½	46⅞	53	44	44½	46⅞	49
46	46½	48	49⅞	46	46½	48⅞	55¼	46	46½	48⅞	51
48	48½	50⅞	51⅞	48	48½	50⅞	58¾	48	48½	50⅞	53
50	50½	52¼	53⅞	50	-	-	-	50	-	-	-
52	52½	54⅞	56⅞	52	-	-	-	52	52½	54¼	57⅞
54	54½	56⅞	58⅞	54	-	-	-	54	54½	56½	59⅞
60	60½	62½	64⅞	60	-	-	-	60	60½	62½	65⅞
66	67⅞	68⅞	70⅞	66	-	-	-	66	66½	68½	72½
72	73⅞	75⅞	76⅞	72	-	-	-	72	75¼	77	78½
84	87	88¾	90¼	84	-	-	-	84	88⅞	90⅞	91⅞
96	99	100¾	102¼	96	-	-	-	96	103¾	102½	104

DIMENSIONS IN INCHES.

STYLE CG & CGI TO BS3381 TO SUIT BS1560 & ASME B16.5 FLANGES

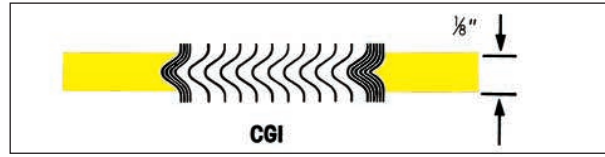
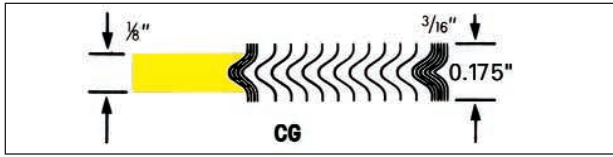

TABLE 9

Nominal Pipe Size	INNER RING	CLASS 150				CLASS 300 to 1500		CLASS 300	CLASS 400	CLASS 600	CLASS 900	CLASS 1500	CLASS 2500		
		SEALING ELEMENT		CENTERING RING	SEALING ELEMENT		CENTERING RING						SEALING ELEMENT		CENTERING RING
		INSIDE DIA.	INSIDE DIA.	OUTSIDE DIA.	OUTSIDE DIA.	INSIDE DIA.	OUTSIDE DIA.	OUTSIDE DIAMETER						INSIDE DIA.	OUTSIDE DIA.
1/4	-	1/2*	7/8	1 3/4	1/2*	7/8	1 3/4	1 3/4	1 3/4	-	-	-	-	-	
1/2	9/16	3/4*	1 1/4	1 7/8	3/4*	1 1/4	2 1/8	2 1/8	2 1/8	2 1/2	2 1/2	3/4	1 1/4	2 3/4	
3/4	1 3/16	1 1/16*	1 9/16	2 1/4	1*	1 9/16	2 5/8	2 5/8	2 5/8	2 3/4	2 3/4	1	1 9/16	3	
1	1 1/16	1 5/16*	1 7/8	2 5/8	1 1/4	1 7/8	2 7/8	2 7/8	2 7/8	3 3/8	3 3/8	1 1/4	1 7/8	3 3/8	
1 1/4	1 3/8	1 13/16*	2 3/8	3	1 3/4	2 7/8	3 1/4	3 1/4	3 1/4	3 1/2	3 1/2	1 9/16	2 3/8	4 1/8	
1 1/2	1 5/8	2 1/8	2 3/4	3 3/8	2*	2 3/4	3 3/4	3 3/4	3 3/4	3 7/8	3 7/8	1 7/8	2 3/4	4 5/8	
2	2 1/16	2 3/4	3 3/8	4 1/8	2 5/8	3 3/8	4 3/8	4 3/8	4 3/8	5 5/8	5 5/8	2 5/16	3 3/8	5 3/4	
2 1/2	2 1/2	3 1/4	3 7/8	4 7/8	3 1/8	3 7/8	5 1/8	5 1/8	5 1/8	6 1/2	6 1/2	2 3/4	3 7/8	6 5/8	
3	3 1/16	4	4 3/4	5 3/8	3 3/4	4 3/4	5 7/8	5 7/8	5 7/8	6 5/8	6 7/8	3 5/8	4 3/4	7 3/4	
3 1/2	3 9/16	4 1/2	5 1/4	6 3/8	4 1/4	5 1/4	6 1/2	6 3/8	6 3/8	-	-	-	-	-	
4	4 1/16	5	5 7/8	6 7/8	4 3/4	5 7/8	7 1/8	7	7 5/8	8 3/8	8 1/4	4 3/4	5 7/8	9 1/4	
4 1/2	4 9/16	5 9/16	6 1/2	7	5 5/16	6 1/2	7 3/4	-	-	-	-	-	-	-	
5	5 1/16	6 1/16	7	7 3/4	5 13/16	7	8 1/2	8 3/8	9 1/2	9 3/4	10	5 13/16	7	11	
6	6 1/16	7 1/8	8 1/4	8 3/4	6 7/8	8 1/4	9 7/8	9 3/4	10 1/2	11 3/8	11 1/8	6 7/8	8 1/4	12 1/2	
8	8	9 1/8	10 3/8	11	8 7/8	10 3/8	12 1/8	12	12 5/8	14 1/8	13 7/8	8 7/8	10 3/8	15 1/4	
10	10	11 5/16	12 1/2	13 3/8	11 1/16	12 1/2	14 1/4	14 7/8	15 3/4	17 1/8	17 1/8	11 1/16	12 1/2	18 3/4	
12	11 15/16	13 3/8	14 3/4	16 1/8	13 3/8	14 3/4	16 5/8	16 1/2	18	19 5/8	20 1/2	13 3/8	14 3/4	21 5/8	
14	13 1/2	14 5/8	16	17 3/4	14 3/8	16	19 1/8	19	19 3/8	20 1/2	22 3/4	-	-	-	
16	15 1/2	16 5/8	18 1/4	20 1/4	16 3/8	18 1/4	21 1/4	21 1/8	22 1/4	22 5/8	25 1/4	-	-	-	
18	17 1/2	18 3/4	20 3/4	21 5/8	18 1/2	20 3/4	23 1/2	23 3/8	24 7/8	25 1/8	27 3/4	-	-	-	
20	19 1/2	20 3/4	22 3/4	23 7/8	20 1/2	22 3/4	25 3/4	25 1/2	26 7/8	27 1/2	29 3/4	-	-	-	
24	23 1/2	24 7/8	27	28 1/4	24 5/8	27	30 1/2	30 1/4	31 1/8	33	35 1/2	-	-	-	

DIMENSIONS IN INCHES.

*These gasket dimensions are not suitable for use with threaded or slip on flanges.
See Table 4 for special sizes.

In accordance with BS 3381 all class 900, 1500 and 2500 gaskets and all gaskets containing PTFE filler material shall have an inner ring.

STYLE CG & CGI TO BS3381 TO SUIT BS1560 & ASME B16.5 FLANGES

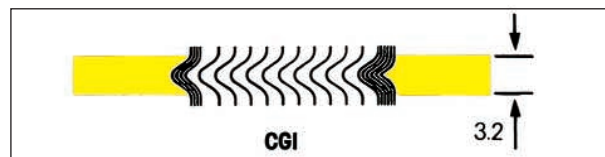
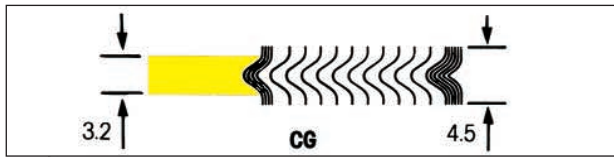

TABLE 10

Nominal Pipe Size	INNER RING	CLASS 150				CLASS 300 to 1500		CLASS 300	CLASS 400	CLASS 600	CLASS 900	CLASS 1500	CLASS 2500		
		SEALING ELEMENT		CENTERING RING	SEALING ELEMENT	CENTERING RING						SEALING ELEMENT		CENTERING RING	
		INSIDE DIA.	INSIDE DIA.	OUTSIDE DIA.	OUTSIDE DIA.	INSIDE DIA.	OUTSIDE DIA.	OUTSIDE DIAMETER						INSIDE DIA.	OUTSIDE DIA.
1/4	-	12.7*	22.2	44.5	12.7*	22.2	44.5	44.5	44.5	-	-	-	-	-	-
1/2	14.3	19.1*	31.8	47.6	19.1*	31.8	54.0	54.0	54.0	63.5	63.5	19.1	31.8	69.9	
3/4	20.6	27.0*	39.7	57.2	25.4*	39.7	66.7	66.7	66.7	69.9	69.9	25.4	39.7	76.2	
1	27.0	33.3*	47.6	66.7	31.8*	47.6	73.0	73.0	73.0	79.4	79.4	31.8	47.6	85.7	
1 1/4	34.9	46.0*	60.3	76.2	44.5*	60.3	82.6	82.6	82.6	88.9	88.9	39.7	60.3	104.8	
1 1/2	41.3	54.0	69.9	85.7	50.8*	69.9	95.3	95.3	95.3	98.4	98.4	47.6	69.9	117.5	
2	52.4	69.9	85.7	104.8	66.7	85.7	111.1	111.1	111.1	142.9	142.9	58.7	85.7	146.1	
2 1/2	63.5	82.6	98.4	123.8	79.4	98.4	130.2	130.2	130.2	165.1	165.1	69.9	98.4	168.3	
3	77.8	101.6	120.7	136.5	95.3	120.7	149.2	149.2	149.2	168.3	174.6	92.1	120.7	196.9	
3 1/2	90.5	114.3	133.4	161.9	108.0	133.4	165.1	161.9	161.9	-	-	-	-	-	
4	103.2	127.0	149.2	174.6	120.7	149.2	181.0	177.8	193.7	206.4	209.6	120.7	149.2	235.0	
4	115.9	141.3	165.1	177.8	134.9	165.1	196.9	-	-	-	-	-	-	-	
5	128.6	154.0	177.8	196.9	147.6	177.8	215.9	212.7	241.3	247.7	254.0	147.6	177.8	279.4	
6	154.0	181.0	209.6	222.3	174.6	209.6	250.8	247.7	266.7	288.9	282.6	174.6	209.6	317.5	
8	203.2	231.8	263.5	279.4	225.4	263.5	308.0	304.8	320.7	358.8	352.4	225.4	263.5	387.4	
10	254.0	287.3	317.5	339.7	281.0	317.5	362.0	358.8	400.1	435.0	435.0	281.0	317.5	476.3	
12	303.2	339.7	374.7	409.6	333.4	374.7	422.3	419.1	457.2	498.5	520.7	333.4	374.7	549.3	
14	342.9	371.5	406.4	450.9	365.1	406.4	485.8	482.6	492.1	520.7	577.9	-	-	-	
16	393.7	422.3	463.6	514.4	415.9	463.6	539.8	536.6	565.2	574.7	641.4	-	-	-	
18	444.5	476.3	527.1	549.3	469.9	527.1	596.9	593.7	612.8	638.2	704.9	-	-	-	
20	495.3	527.1	577.9	606.4	520.7	577.9	654.1	647.7	682.6	698.5	755.7	-	-	-	
24	596.9	631.8	685.8	717.6	625.5	685.8	774.7	768.4	790.6	838.2	901.7	-	-	-	

DIMENSIONS IN mm.

*These gasket dimensions are not suitable for use with threaded or slip on flanges.
See Table 4 for special sizes.

In accordance with BS 3381 all class 900, 1500 and 2500 gaskets and all gaskets containing PTFE filler material shall have an inner ring.

STYLE CG & CGI TO SUIT BS10 FLANGES

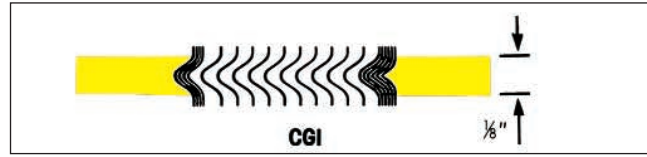
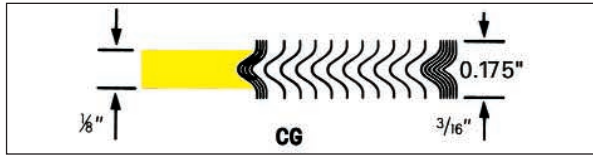

TABLE
11

Nominal Pipe Size	TABLE D-R	TABLE D & E		TABLE D	TABLE E	TABLE F to R		TABLE F	TABLE H	TABLE J	TABLE K	TABLE R	TABLE S			TABLE T		
	INNER RING	SEALING ELEMENT		CENTERING RING		SEALING ELEMENT		CENTERING RING					SEALING ELEMENT	CENTERING RING	SEALING ELEMENT	CENTERING RING		
	ID	ID	OD	OD	OD	ID	OD	OUTSIDE DIAMETER					ID	OD	OD	ID	OD	OD
1/2	9/16	1 1/32	1 15/32	2 1/8	2 1/8	1 17/32	1 17/32	2 1/8	2 5/8	2 5/8	2 5/8	2 5/8	3/4	1 1/4	2 3/4	3/4	1 1/4	3 1/4
3/4	1 3/16	1 1/4	1 11/16	2 3/8	2 3/8	1 1/4	1 3/4	2 3/8	2 5/8	2 5/8	2 5/8	2 5/8	1	1 1/16	2 3/4	1	1 1/16	3 1/4
1	1 1/16	1 1/16	2 1/16	2 3/4	2 3/4	1 9/16	2 3/16	2 13/16	2 13/16	2 13/16	3 1/8	3 3/8	1 1/4	1 7/8	3 1/4	1 1/4	1 7/8	3 1/2
1 1/4	1 5/16	1 7/8	2 3/8	2 15/16	2 15/16	1 7/8	2 1/2	3 1/4	3 1/4	3 1/4	3 1/4	3 1/4	1 1/2	2 3/16	3 1/2	1 5/8	2 5/16	3 3/8
1 1/2	1 1/16	2 1/8	2 5/8	3 3/8	3 3/8	2 1/8	2 3/4	3 1/2	3 1/2	3 1/2	3 3/4	3 3/4	1 3/4	2 1/2	4	1 7/8	2 5/8	4 1/2
2	2 1/16	2 5/8	3 3/8	3 7/8	3 7/8	2 5/8	3 1/4	4 3/8	4 3/8	4 1/4	4 3/8	4 3/8	2 1/4	3 3/8	4 1/2	2 5/8	3 1/4	5
2 1/2	2 5/16	3 1/4	3 7/8	4 3/8	4 3/8	3 1/4	4	5 1/8	5 1/8	5	5	5	2 7/8	3 3/4	5	3	3 7/8	5 5/8
3	3 1/16	3 13/16	4 7/16	5 1/8	5 1/8	3 13/16	4 9/16	5 7/8	5 7/8	5 3/4	5 3/4	5 3/4	3 3/8	4 1/4	5 5/8	3 1/2	4 1/2	6 1/2
3 1/2	3 5/16	4 5/16	4 15/16	5 7/8	5 7/8	4 5/16	5 1/16	6 3/8	6 3/8	6 1/4	6 3/8	6 3/8	3 7/8	4 3/4	6 3/8	4	5 1/8	7 3/8
4	4 1/16	4 7/8	5 1/2	6 3/8	6 3/8	4 7/8	5 5/8	6 7/8	6 7/8	6 3/4	6 7/8	6 7/8	4 3/8	5 3/8	7	4 1/2	5 5/8	8 1/8
4 1/2	4 5/16	5 3/8	6	6 7/8	6 7/8	5 3/8	6 1/4	7 1/2	7 1/2	7 3/8	7 3/8	7 3/8	4 7/8	5 7/8	7 1/2	5	6 1/4	9
5	5 1/16	5 7/8	6 1/2	7 5/8	7 5/8	5 7/8	6 3/4	8 1/2	8 1/2	8 3/8	8 3/8	8 3/8	5 3/8	6 3/8	8 3/8	5 1/2	6 3/4	9 5/8
6	6 1/16	6 7/8	7 1/2	8 5/8	8 1/2	6 7/8	7 3/4	9 1/2	9 1/2	9 3/8	9 3/8	9 3/8	6 3/8	7 3/8	9 3/4	6 1/2	7 3/4	11 1/4
7	7 1/16	7 7/8	8 5/8	9 5/8	9 1/2	7 7/8	8 7/8	10 3/4	10 3/4	10 5/8	10 1/2	10 1/2	7 3/8	8 5/8	11 3/8	7 1/2	9	13 3/8
8	8 1/16	8 7/8	9 5/8	10 7/8	10 3/4	8 7/8	9 7/8	12	12	11 7/8	11 1/2	11 3/4	8 3/8	9 5/8	12 3/4	8 1/2	10	14 1/2
9	9 1/16	9 7/8	10 5/8	12 1/8	12	9 7/8	10 7/8	13 3/8	13 3/8	13	13	13	9 1/2	10 3/4	14 1/8	9 5/8	11 1/4	16 1/8
10	10 1/16	10 7/8	11 5/8	13 1/4	13 1/4	11	12	14 1/8	14 1/8	14	14	14 1/4	10 1/2	11 7/8	15 1/2	10 5/8	12 1/4	17 3/4
11	11 1/16	11 7/8	12 5/8	14 1/4	14 1/4	12	13	15 1/8	15 1/8	15	15 1/8	15 7/8	11 1/2	12 7/8	17 1/8	11 5/8	13 1/4	19 1/4
12	12 1/16	12 7/8	13 3/4	15 1/4	15 1/8	13	14 1/8	16 3/8	16 3/8	16 1/4	15 7/8	16 7/8	12 5/8	14	18 1/2	12 3/4	14 1/2	20 3/4
13	13 1/16	14 1/2	15 5/8	16 1/2	16 3/8	14 1/4	15 5/8	17 1/2	17 1/2	17 3/8	17 3/4	18 1/4	13 5/8	15 5/8	19 3/4	13 3/4	15 1/2	22
14	14 1/16	15 1/2	16 3/8	17 5/8	17 5/8	15 1/4	16 3/8	18 1/2	18 1/2	18 3/8	18 3/4	19 1/2	14 5/8	16 1/8	21 1/4	-	-	-
15	15 1/16	16 1/2	17 3/8	18 5/8	18 5/8	16 1/4	17 3/8	19 1/2	19 1/2	19 3/8	20	20 1/2	15 3/4	17 1/4	22 7/8	-	-	-
16	16 1/16	17 1/2	18 3/8	19 5/8	19 5/8	17 1/2	18 3/4	20 3/4	20 3/4	20 5/8	21	21 3/4	16 3/4	18 3/8	24 1/4	-	-	-
17	17 1/16	18 5/8	19 5/8	20 7/8	20 3/4	18 1/2	19 5/8	22	22	21 7/8	22 1/4	22 3/4	-	-	-	-	-	-
18	18 1/16	19 5/8	20 5/8	22 1/8	22 1/8	19 1/2	20 7/8	22 7/8	22 7/8	22 3/4	24 3/8	25 1/8	-	-	-	-	-	-
19	19 1/16	20 5/8	21 5/8	23 3/8	23 3/8	20 5/8	22 1/8	24 1/8	24 1/8	24	-	-	-	-	-	-	-	-
20	20 1/16	21 5/8	22 5/8	24 3/8	24 3/8	21 5/8	23 3/8	25 3/8	25 3/8	25 1/4	26 1/2	27 1/4	-	-	-	-	-	-
21	21 1/16	22 5/8	23 3/4	25 5/8	25 1/2	22 5/8	24 3/8	26 3/8	26 3/8	26 1/4	-	-	-	-	-	-	-	-
22	22 1/16	23 5/8	24 3/4	26 1/2	26 1/2	23 5/8	25 3/8	27 3/8	27 3/8	27 1/4	28 3/4	29 3/4	-	-	-	-	-	-
23	23 1/16	24 5/8	25 3/4	27 1/2	27 1/2	24 5/8	26 3/8	28 1/2	28 1/2	28 3/8	-	-	-	-	-	-	-	-
24	24 1/16	25 5/8	26 3/4	28 3/4	28 5/8	25 5/8	27 3/8	29 1/2	29 1/2	29 3/8	-	-	-	-	-	-	-	-

DIMENSIONS IN INCHES.

NOTE: Special gasket dimensions are required when an inner ring is fitted to gaskets for Tables S and T. Please request details.

STYLE CG & CGI TO BS 4865 PART 2 TO SUIT BS 4504 FLANGES

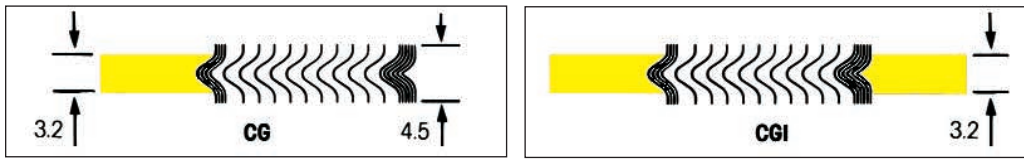

TABLE
12

Nominal Pipe Size	Inner Ring Inside Diameter	Sealing Element PN10-PN40		Centering Ring Outside Diameter			
		Inside Dia.	Outside Dia.	PN10	PN16	PN25	PN40
10	15	23.6	36.4	48	48	48	48
15	19	27.6	40.4	53	53	53	53
20	24	33.6	47.4	63	63	63	63
25	30	40.6	55.4	73	73	73	73
32	39	49.6	66.4	84	84	84	84
40	45	55.6	72.4	94	94	94	94
50	56	67.6	86.4	109	109	109	109
65	72	83.6	103.4	129	129	129	129
80	84	96.6	117.4	144	144	144	144
100	108	122.6	144.4	164	164	170	170
125	133	147.6	170.4	194	194	196	196
150	160	176.6	200.4	220	220	226	226
200	209	228.6	255.4	275	275	286	293
250	262	282.4	310.4	330	331	343	355
300	311	331.6	360.4	380	386	403	420
350	355	374.6	405.4	440	446	460	477
400	406	425.6	458.4	491	498	517	549
450	452	476.6	512.4	541	558	567	574
500	508	527.6	566.4	596	620	627	631
600	610	634.6	675.4	698	737	734	750
700	710	734.0	778.5	813	807	836	-
800	811	835.0	879.5	920	914	945	-
900	909	933.0	980.5	1020	1014	1045	-

DIMENSIONS IN mm.

The use of an inner ring is recommended for gaskets for use with PN25 and PN40 flanges.
Inner rings may be fitted also to gaskets for use with PN10 and PN16 flanges.

STYLE CG & CGI TO SUIT DIN FLANGES PN 10-PN 250

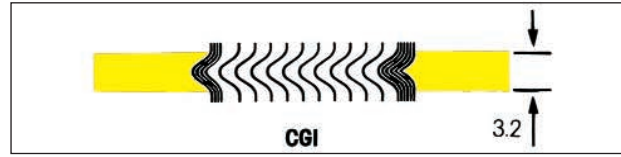
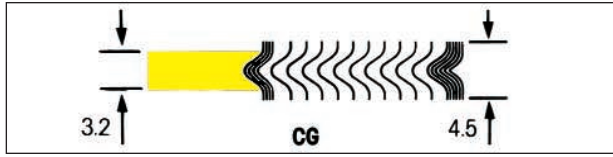

TABLE
13

NOMINAL PIPE SIZE (DN)	INNER RING INSIDE DIAMETER	SEALING ELEMENT INSIDE DIAMETER	SEALING ELEMENT OUTSIDE DIAMETER		(DN)							
			PN10-PN40	PN64-PN250	PN10	PN16	PN25	PN40	PN64	PN100	PN160	PN250
10	18	24	36	36	46	46	46	46	56	56	56	67
15	24	30	42	42	51	51	51	51	61	61	61	72
20	27	33	47	47	61	61	61	61	72	72	-	-
25	34	40	54	54	71	71	71	71	82	82	82	83
32	44	50	66	66	82	82	82	82	87	87	-	-
40	51	57	73	73	92	92	92	92	103	103	103	109
50	59	69	87	87	107	107	107	107	113	119	119	124
65	73	83	103	105	127	127	127	127	138	144	144	154
80	87	97	117	121	142	142	142	142	148	154	154	170
100	114	124	144	148	162	162	168	168	174	180	180	202
125	140	150	172	176	192	192	194	194	210	217	217	242
150	168	178	200	204	217	217	224	224	247	257	257	284
175	189	199	225	231	247	247	254	265	277	287	284	316
200	220	230	256	262	272	272	284	290	309	324	324	358
250	269	279	307	315	327	328	340	352	364	391	388	442
300	319	329	357	365	377	383	400	417	424	458	458	538
350	365	375	405	413	437	443	457	474	486	512	-	-
400	416	426	458	466	488	495	514	546	543	572	-	-
500	520	530	566	574	593	617	624	628	657	704	-	-
600	615	630	666	674	695	734	731	747	764	813	-	-
700	715	730	770	778	810	804	833	852	879	-	-	-
800	815	830	874	882	917	911	942	974	988	-	-	-
900	915	930	974	982	1017	1011	1042	1084	1108	-	-	-
1000	1015	1030	1078	1086	1124	1128	1154	1194	1220	-	-	-

DIMENSIONS IN mm.

The use of an inner ring is recommended for gaskets for use with PN100 Flanges and above.
Gasket dimensions are available to suit PN320 Flanges, consult the technical department.

STYLE R

FOR USE WITH MALE & FEMALE AND TONGUE & GROOVE ASME B16.5 & BS 1560 FLANGES

Standard Style R gaskets embody all the exclusive features of Flexitallic design for keeping compression values in balance with bolting and providing adequate resilience to compensate for variable stresses encountered in service. Standard Style R gaskets are manufactured to a nominal thickness of .125" (3.2mm). Optimum compression is in the range of .090" to .100" (2.3mm to 2.5mm) thick.

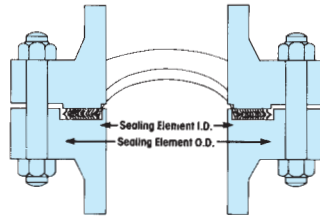

There are three types of Style R gaskets:

- (a) Style R-1 indicates gaskets for use with large male and female flanges.*
- (b) Style R-3 indicates gaskets for use with large tongue and groove flanges.
- (c) Style R-4 indicates gaskets for use with small tongue and groove flanges.

*As a general rule, the use of Flexitallic Spiral-Wound Gaskets with small male and female flange facings is not recommended.

Dimensional limitations established by the proportions of the small tongue and groove facings limit the possibility of increasing gasket dimensions to improve the load carrying capacity in the higher pressure series. For this reason, it is suggested that large tongue and groove facings be selected for new construction when class 900, 1500 and 2500 flanges are to be used. Style R-4 gaskets may be compressed an additional amount when exposed to the higher bolt loads, but not to the degree that the gasket will be crushed due to the radial support provided by the confining groove.

Special Style R gaskets are adaptable to non-standard flanges and can be designed and manufactured according to specifications for high and low pressure applications and for severe corrosive conditions.

When ordering special Style R gaskets for non-standard flanges and for special applications, furnish complete data on Flexitallic Gasket Engineering Data Form.

NOTE - The following Style R gaskets are interchangeable:

Style R-1 and R-3 gaskets

- 1/4" sizes - Classes 150, 300, 400 and 600 are interchangeable.
- 1/2" sizes - Classes 150, 300, 400, 600, 900, 1500 and 2500 (R-3 only) are interchangeable.
- All R-1 and R-3 gaskets in Classes 300, 400 and 600 are interchangeable within their size category.
- All R-1 and R-3 gaskets in Classes 900 and 1500 are interchangeable within their size category.

Style R-4 gaskets

- 1/2" sizes - interchangeable with all NPS 1/2" R-1 and R-3 gaskets within the same pressure rating.
- 3/4" interchangeable with all 3/4" R-1 and R-3 gaskets within the same pressure rating.
- All R-4 gaskets in Classes 300 through 2500 are interchangeable within their size category.

TABLE 14

Nominal Pipe Size	Style R1 for Large Male and Female								Style R3 for Large Tongue and Groove				Style R4 for Small Tongue and Groove			
	Sealing Element Class 150-1500				Sealing Element Class 2500				Sealing Element Class 150-2500				Sealing Element Class 150-2500			
	ID	OD	ID	OD	ID	OD	ID	OD	ID	OD	ID	OD	ID	OD		
1/4	1/2	12.7	1	25.4	-	-	-	-	1/2	12.7	1	25.4	-	-	-	-
1/2	1	25.4	1 3/8	34.9	1 3/16	20.6	1 3/8	34.9	1	25.4	1 3/8	34.9	1	25.4	1 3/8	34.9
3/4	1 1/16	33.3	1 1/16	42.9	1 1/16	27.0	1 1/16	42.9	1 1/16	33.3	1 1/16	42.9	1 1/16	33.3	1 1/16	42.9
1	1 1/2	38.1	2	50.8	1 1/4	31.8	2	50.8	1 1/2	38.1	2	50.8	1 1/2	38.1	1 3/8	47.6
1 1/4	1 7/8	47.6	2 1/2	63.5	1 5/8	41.3	2 1/2	63.5	1 7/8	47.6	2 1/2	63.5	1 7/8	47.6	2 1/4	57.2
1 1/2	2 1/8	54.0	2 7/8	73.0	1 7/8	47.6	2 7/8	73.0	2 1/8	54.0	2 7/8	73.0	2 1/8	54.0	2 1/2	63.5
2	2 3/8	73.0	3 5/8	91.1	2 3/8	60.3	3 5/8	92.1	2 3/8	73.0	3 5/8	92.1	2 3/8	73.0	3 1/4	82.6
2 1/2	3 3/8	85.7	4 1/8	104.8	3	76.2	4 1/8	104.8	3 3/8	85.7	4 1/8	104.8	3 3/8	85.7	3 3/4	95.3
3	4 1/4	108.0	5	127.0	3 3/4	95.3	5	127.0	4 1/4	108.0	5	127.0	4 1/4	108.0	4 5/8	117.5
3 1/2	4 3/4	120.7	5 1/2	139.7	-	-	-	-	4 3/4	120.7	5 1/2	139.7	4 3/4	120.7	5 1/8	130.2
4	5 3/16	131.8	6 3/16	157.2	4 3/4	120.7	6 3/16	157.2	5 3/16	131.8	6 3/16	157.2	5 3/16	131.8	5 1/16	144.5
4 1/2	5 11/16	144.5	6 3/4	171.5	-	-	-	-	5 11/16	144.5	6 3/4	171.5	-	-	-	-
5	6 5/16	160.3	7 5/16	185.7	5 3/4	146.1	7 5/16	185.7	6 5/16	160.3	7 5/16	185.7	6 5/16	160.3	6 13/16	173.0
6	7 1/2	190.5	8 1/2	215.9	6 3/4	171.5	8 1/2	215.9	7 1/2	190.5	8 1/2	215.9	7 1/2	190.5	8	203.2
8	9 3/8	238.1	10 5/8	269.9	8 3/4	222.3	10 5/8	269.9	9 3/8	238.1	10 5/8	269.9	9 3/8	238.1	10	254.0
10	11 1/4	285.8	12 3/4	323.9	10 3/4	273.1	12 3/4	323.9	11 1/4	285.8	12 3/4	323.9	11 1/4	285.8	12	304.8
12	13 1/2	342.9	15	381.0	13	330.2	15	381.0	13 1/2	342.9	15	381.0	13 1/2	342.9	14 1/4	362.0
14	14 3/4	374.7	16 1/4	412.8	-	-	-	-	14 3/4	374.7	16 1/4	412.8	14 3/4	374.7	15 1/2	393.7
16	17	425.5	18 1/2	469.9	-	-	-	-	17	425.5	18 1/2	469.9	16 3/4	425.5	17 7/8	447.7
18	19 3/4	489.0	21	533.4	-	-	-	-	19 3/4	489.0	21	533.4	19 3/4	489.0	20 1/8	511.2
20	21	533.4	23	584.2	-	-	-	-	21	533.4	23	584.2	21	533.4	22	558.2
24	25 1/4	641.4	27 1/4	692.2	-	-	-	-	25 1/4	641.4	27 1/4	692.2	25 1/4	641.4	26 1/4	666.8

DIMENSIONS IN INCHES & mm.

NOTE: Style R3 for NPS 1/4 are for class 150 to 600 only. Style R3 for NPS 4 1/2 are for class 150 to 1500 only.

STYLE RIR

FOR USE WITH LARGE MALE & FEMALE ASME B16.5 and BS1560 FLANGES

TABLE 15

Nominal Pipe Size	Style R1 for Large Male and Female									
	Inner Ring		Sealing Element Class 2500				Sealing Element Class 150-2500			
	ID		ID	OD		ID	OD		ID	OD
1/4	-	-	1/2	12.7	1	25.4	-	-	-	-
1/2	9/16	14.3	1	25.4	1 3/8	34.9	1 3/16	20.6	1 3/8	34.9
3/4	1 3/16	20.6	1 5/16	33.3	1 11/16	42.9	1 1/16	27.0	1 11/16	42.9
1	1 1/16	27.0	1 1/2	38.1	2	50.8	1 1/4	31.8	2	50.8
1 1/4	1 3/8	34.9	1 7/8	47.6	2 1/2	63.5	1 5/8	41.3	2 1/2	63.5
1 1/2	1 5/8	41.3	2 1/8	54.0	2 7/8	73.0	1 7/8	47.6	2 7/8	73.0
2	2 1/16	52.4	2 3/8	73.0	3 5/8	92.1	2 3/8	60.3	3 5/8	92.1
2 1/2	2 1/2	63.5	3 3/8	85.7	4 1/8	104.8	3	76.2	4 1/8	104.8
3	3 1/16	77.8	4 1/4	108.0	5	127.0	3 3/4	95.3	5	127.0
3 1/2	3 1/16	90.5	4 3/4	120.7	5 1/2	139.7	-	-	-	-
4	4 1/16	103.2	5 3/16	131.8	6 3/16	157.2	4 3/4	120.7	6 3/16	157.2
4 1/2	4 9/16	115.9	5 11/16	144.5	6 3/4	171.5	-	-	-	-
5	5 1/16	128.6	6 5/16	160.3	7 5/16	185.7	5 3/4	146.1	7 5/16	185.7
6	6 1/16	154.0	7 1/2	190.5	8 1/2	215.9	6 3/4	171.5	8 1/2	215.9
8	8	203.2	9 3/8	238.1	10 5/8	269.9	8 3/4	222.3	10 5/8	269.9
10	10	254.0	11 1/4	285.8	12 3/4	323.9	10 3/4	273.1	12 3/4	323.9
12	11 15/16	303.2	13 1/2	342.9	15	381.0	13	330.2	15	381.0
14	13 1/2	342.9	14 3/4	374.7	16 1/4	412.8	-	-	-	-
16	15 1/2	393.7	16 3/4	425.5	18 1/2	469.9	-	-	-	-
18	17 1/2	444.5	19 1/4	489.0	21	533.4	-	-	-	-
20	19 1/2	495.3	21	533.4	23	584.2	-	-	-	-
24	23 1/2	596.9	25 1/4	641.4	27 1/4	692.2	-	-	-	-

DIMENSIONS IN INCHES & mm.

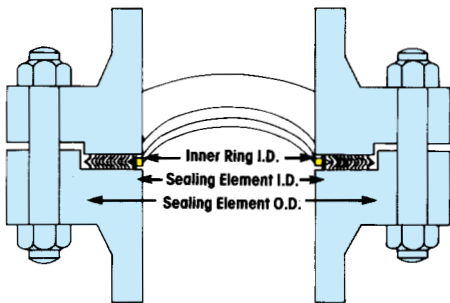

Standard 'RIR' gaskets are manufactured to 0.125" (3.2mm) thickness. The gasket features a solid metal inner ring nominally 0.090" (2.3mm) thick, as an integrated part of its design. The inner ring provides a positive stop preventing the gasket from over compression and possible damage. Special styles are available in other thickness.

STYLE CG & CGI TO SUIT JIS FLANGES PRESSURE RATING 10Kgf/cm² – 16-20Kgf/cm²

TABLE 16

Nom. Pipe Size	Inner Ring Inside Dia.	Sealing Element		Centering Ring Outside Dia.
		Inside Dia.	Outside Dia.	
10	-	24	37	52
15	-	28	41	57
20	-	34	47	62
25	-	40	53	74
32	-	51	67	84
40	-	57	73	89
50	-	69	89	104
65	-	87	107	124
80	-	98	118	134
90	-	110	130	144
100	-	123	143	159
125	-	148	173	190
150	-	174	199	220
175	-	201	226	245
200	-	227	252	270
225	-	252	277	290
250	-	278	310	332
300	-	329	361	377
350	-	366	406	422
400	-	417	457	484
450	-	468	518	539
500	-	518	568	594
550	-	569	619	650
600	-	620	670	700

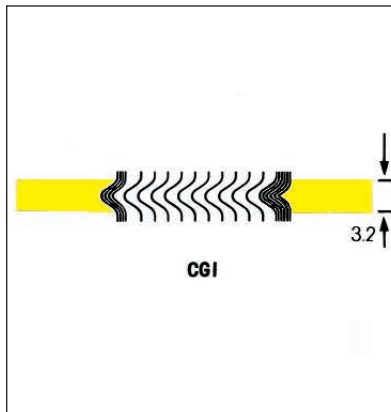
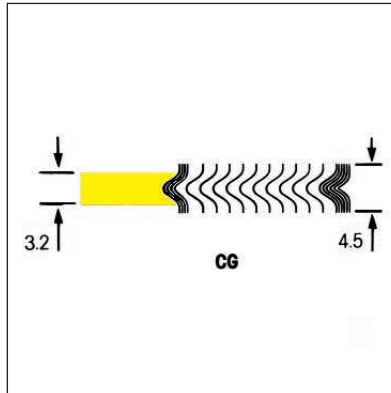

Nom. Pipe Size	Inner Ring Inside Dia.	Sealing Element		Centering Ring Outside Dia.
		Inside Dia.	Outside Dia.	
10	18	24	37	52
15	22	28	41	57
20	28	34	47	62
25	34	40	53	74
32	43	51	67	84
40	49	57	73	89
50	61	69	89	104
65	77	87	107	124
80	89	99	119	140
90	102	114	139	150
100	115	127	152	165
125	140	152	177	202
150	166	182	214	237
175	-	-	-	-
200	217	233	265	282
225	-	-	-	-
250	268	288	328	354
300	319	339	379	404
350	356	376	416	450
400	407	432	482	508
450	458	483	533	573
500	508	533	583	628
550	559	584	634	684
600	610	635	685	734

DIMENSIONS IN mm.

STYLE CG & CGI TO SUIT JIS FLANGES PRESSURE RATING 30Kgf/cm² - 63Kgf/cm²

TABLE 17

Nom. Pipe Size	Inner Ring Inside Dia.	Sealing Element		Centering Ring Outside Dia.
		Inside Dia.	Outside Dia.	
10	18	24	37	59
15	22	28	41	64
20	28	34	47	69
25	34	40	53	79
32	43	51	67	89
40	49	57	73	100
50	61	69	89	114
65	68	78	98	140
80	80	90	110	150
90	92	102	127	162
100	104	116	141	172
125	128	140	165	207
150	153	165	197	249
200	202	218	250	294
250	251	271	311	360
300	300	320	360	418
350	336	356	396	463
400	383	403	453	524

Nom. Pipe Size	Inner Ring Inside Dia.	Sealing Element		Centering Ring Outside Dia.
		Inside Dia.	Outside Dia.	
10	15	21	34	59
15	18	24	37	64
20	23	29	42	69
25	29	35	48	79
32	38	44	60	89
40	43	51	67	100
50	55	63	79	114
65	68	78	98	140
80	80	90	110	150
90	92	102	127	162
100	104	116	141	182
125	128	140	165	224
150	153	165	197	265
200	202	218	250	315
250	251	271	311	378
300	300	320	360	434
350	336	356	396	479
400	383	403	453	531

Nom. Pipe Size	Inner Ring Inside Dia.	Sealing Element		Centering Ring Outside Dia.
		Inside Dia.	Outside Dia.	
10	15	21	34	64
15	18	24	37	69
20	23	29	42	75
25	29	35	48	80
32	38	44	60	90
40	43	51	67	107
50	55	63	79	125
65	68	78	98	152
80	80	90	110	162
90	92	102	127	179
100	104	116	141	194
125	128	140	165	235
150	153	165	197	275
200	202	218	250	328
250	251	271	311	394
300	300	320	360	446
350	336	356	396	488
400	383	403	453	545

DIMENSIONS IN mm.

STYLE CG-RJ & CGI-RJ SPIRAL-WOUND GASKETS FOR USE IN ASME B16.5 AND API 6A RING-JOINT FLANGES

CG-RJ and CGI-RJ spiral wound gaskets are designed for use, as a replacement maintenance item, of standard oval and octagonal ring joint gaskets.

These gaskets are available for NPS 1/2 to 24 and pressure classes 150 to 1500.

Gasket thickness is 0.175" (4.5mm) and the outer ring thickness is 0.125" (3.2mm).

Style CGI-RJ gaskets are fitted with an inner ring 0.125 (3.2mm) thick.

Flexitallic recommends CGI-RJ gaskets for pressure classes 900 and above, and where operating temperatures are above 572 F (300 C).

Consult our technical department for CGI-RJ gasket dimensions.

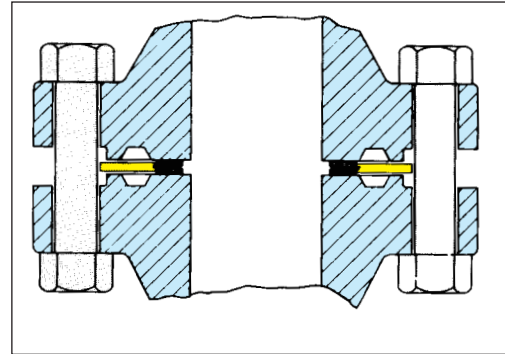

Note: Clearance dimensions between flange faces should be checked on close coupling pipework prior to installation of CG-RJ and CGI-RJ gaskets to ensure that optimum compression can be achieved without over stressing bolts and or flanges.

It is the user's responsibility to ensure that there is sufficient clearance between the flange bore and ring groove for proper seating of the gasket.

Dimensions are listed below for CG-RJ spiral wound gaskets. Flexitallic's technical department should be consulted for CGI-RJ and API gasket sizes.

TABLE
18

Nom. Pipe Size	PRESSURE CLASS																	
	150			300			400			600			900			1500		
	Gasket ID	Gasket OD	Ring OD	Gasket ID	Gasket OD	Ring OD	Gasket ID	Gasket OD	Ring OD	Gasket ID	Gasket OD	Ring OD	Gasket ID	Gasket OD	Ring OD	Gasket ID	Gasket OD	Ring OD
1/2	-	-	-	1 1/16	1 1/16	2 1/8	1 1/16	1 1/16	2 1/8	1 1/16	1 1/16	2 1/8	1 1/16	1 1/16	2 1/2	1 1/16	1 1/16	2 1/2
3/4	-	-	-	7/8	1 5/16	2 5/8	7/8	1 5/16	2 5/8	7/8	1 5/16	2 5/8	7/8	1 3/8	2 3/4	7/8	1 3/8	2 3/4
1	1 1/8	1 5/8	2 5/8	1 1/8	1 5/8	2 7/8	1 1/8	1 5/8	2 7/8	1 1/8	1 5/8	2 7/8	1 1/8	1 5/8	3 1/8	1 1/8	1 5/8	3 1/8
1 1/4	1 7/16	1 7/8	3	1 7/16	2	3 1/4	1 7/16	2	3 1/4	1 7/16	2	3 1/4	1 7/16	2	3 1/2	1 7/16	2	3 1/2
1 1/2	1 11/16	2 3/16	3 3/8	1 11/16	2 3/8	3 3/4	1 11/16	2 3/8	3 3/4	1 11/16	2 3/8	3 3/4	1 11/16	2 3/8	3 3/8	1 11/16	2 3/8	3 3/8
2	2 1/8	2 7/8	4 1/8	2 1/8	2 3/4	4 3/8	2 1/8	2 3/4	4 3/8	2 1/8	2 3/4	4 3/8	2 1/8	3 1/4	5 5/8	2 1/8	3 1/4	5 5/8
2 1/2	2 3/4	3 5/16	4 7/8	2 3/4	3 5/16	5 1/8	2 3/4	3 5/16	5 1/8	2 3/4	3 5/16	5 1/8	2 3/4	3 3/8	6 1/2	2 3/4	3 3/8	6 1/2
3	3 5/16	3 15/16	5 3/8	3 5/16	3 15/16	5 7/8	3 5/16	3 15/16	5 7/8	3 5/16	3 15/16	5 7/8	3 5/16	4 3/16	6 5/8	3 5/16	4 11/16	6 7/8
4	4 5/16	5 3/16	6 7/8	4 5/16	5 3/16	7 1/8	4 5/16	5 3/16	7 1/8	4 5/16	5 3/16	7 1/8	4 5/16	5 3/16	8 1/8	4 5/16	5 11/16	8 1/4
5	5 5/16	6 3/16	7 3/4	5 5/16	6 7/16	8 1/2	5 5/16	6 7/16	8 3/8	5 5/16	6 7/16	8 3/8	5 5/16	6 7/16	9 3/4	5 5/16	6 15/16	10
6	6 5/16	7 3/16	8 3/4	6 5/16	7 5/8	9 7/8	6 5/16	7 5/8	9 3/4	6 5/16	7 5/8	10 1/2	6 5/16	7 5/8	11 3/8	6 5/16	7 9/16	11 1/8
8	8 1/4	9 3/16	11	8 1/4	9 15/16	12 1/8	8 1/4	9 15/16	12	8 1/4	9 15/16	12 5/8	8 1/4	9 15/16	14 7/8	8 1/4	9 3/4	13 3/8
10	10 5/16	11 7/16	13 3/8	10 5/16	12	14 1/4	10 5/16	12	14 1/8	10 5/16	12	15 3/4	10 5/16	12	17 1/8	10 1/4	11 7/8	17 1/8
12	12 3/16	13 9/16	16 1/8	12 3/16	14 1/4	16 5/8	12 3/16	14 1/4	16 1/2	12 3/16	14 1/4	18	12 3/16	14 1/4	19 5/8	11 15/16	13 13/16	20 1/2
14	13 7/16	14 15/16	17 3/4	14 1/4	15 3/4	19 1/8	14 1/4	15 3/4	19	14 1/4	15 3/4	19 3/8	13 13/16	15 5/8	20 1/2	13 7/16	15 3/8	22 3/4
16	15 1/2	16 15/16	20 1/4	16 1/4	17 3/4	21 1/4	16 1/4	17 3/4	21 1/8	16 1/4	17 3/4	22 1/4	15 5/16	17 9/16	22 5/8	15	17	25 1/4
18	17 1/4	19	21 5/8	18 1/4	20 1/4	23 1/2	18 1/4	20 1/4	23 3/8	18 1/4	20 1/4	24 1/8	17 11/16	19 5/16	25 1/8	17 1/4	19 1/2	27 3/4
20	19 3/4	21 1/8	23 7/8	20 1/4	22 3/16	25 3/4	20 1/4	22 3/16	25 1/2	20 1/4	22 3/16	26 7/8	19 11/16	21 5/16	27 1/2	19 3/16	21 7/16	29 3/4
24	23 1/2	25 1/4	28 1/4	24 1/4	26 5/16	30 1/2	24 1/4	26 5/16	30 1/4	24 1/4	26 5/16	31 1/8	23 3/16	25 5/16	33	23 1/4	25 1/2	35 1/2

DIMENSIONS IN INCHES.

STYLE 625 GASKETS FOR CLAMP-TYPE AND OTHER NON-STANDARD FLANGE ASSEMBLIES

Style 625 gaskets were originally designed by Flexitallic for clamp-type closures in aircraft, but are now widely used wherever space limitations indicate the need for a wafer-thin or narrow spiral wound gasket.

Style 625 gaskets are manufactured to a nominal thickness of .0625", with compression to .050" - .055".

Style 625 gaskets embody all of the exclusive features of Flexitallic design for keeping compression values in balance with bolting and providing correct resiliency to compensate for variable stresses encountered in service.

Style 625 gaskets can be manufactured from any combination of materials shown on page 7. Please check with Flexitallic for manufacturing limitations on Style 625 gasket larger than 8" I.D. or 3/8" radial width.

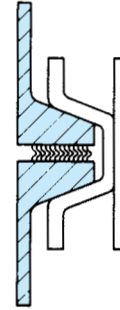

TABLE
19

GASKET I.D. (Inches)	GASKET O.D. (Inches)	GASKET IDENTIFICATION NUMBER	ORIGINAL PART NUMBER
1 1/8	1 5/8	VC-06-1.00	750244-3
1 3/8	1 7/8	VC-06-1.25	750244-4
1 5/8	2 1/8	VC-06-1.50	750244-5
1 7/8	2 3/8	VC-06-1.75	750244-6
2 1/8	2 5/8	VC-06-2.00	750244-7
2 3/8	2 7/8	VC-06-2.25	750244-8
2 5/8	3 1/8	VC-06-2.50	750244-9
2 7/8	3 3/8	VC-06-2.75	750244-10
3 1/8	3 5/8	VC-06-3.00	750244-11
3 1/4	3 3/4	VC-06-3.15	750244-12
3 3/8	3 7/8	VC-06-3.25	750244-13
3 5/8	4 1/8	VC-06-3.50	750244-14
3 7/8	4 3/8	VC-06-3.75	750244-15
4 1/8	4 5/8	VC-06-4.00	750244-16
4 5/8	5 1/8	VC-06-4.50	750244-17
5 1/8	5 5/8	VC-06-5.00	750244-18
5 5/8	6 1/8	VC-06-5.50	750244-19
6 1/8	6 5/8	VC-06-6.00	750244-20

DIMENSIONS IN INCHES.

USEFUL TECHNICAL DATA

Gasket Style Selection

Ensure that the correct style of gasket has been selected for the appropriate application.

Note:

Flexitallic recommended Style CG Spiral Wound Gaskets up to and including Class 600 rating.

Style CGI Gaskets should be employed for pressure Classes 900 and above.

All PTFE filled Spiral Wound Gaskets for raised face and flat face flanges should utilize an inner and outer guide ring.

When using Style 'R' Spiral Wound Gaskets ensure that a compression stop is incorporated into the flange arrangement.

Required Gasket Compression

For optimum sealing performance Flexitallic Spiral Wound Gaskets should be compressed to the following thicknesses:

INITIAL GASKET THICKNESS	RECOMMENDED COMPRESSED THICKNESS
1.6mm (0.0625in)	1.3/1.4mm (0.050in/0.055in)
2.5mm (0.100in)	1.9/2.0mm (0.075in/0.080in)
3.2mm (0.125in)	2.3/2.5mm (0.090in/0.100in)
4.5mm (0.175in)	3.2/3.4mm (0.125in/0.135in)
6.4mm (0.250in)	4.6/5.1mm (0.180in/0.200in)
7.2mm (0.285in)	5.1/5.6mm (0.200in/0.220in)

Spiral Wound Gaskets with internal or external guide rings i.e. Style CG and CGI, should be fully compressed to the guide ring. This will not damage the gasket or affect the sealing performance, since the rings are provided as a compression limiting stop.

USEFUL ASSEMBLY TECHNIQUES

Flanges

Check that the flange faces are clean, in good condition and with a turned surface finish within the following range Ra 3.2 to 6.3 micro metres (125 to 250 micro inches).

Bolting

Ensure that the correct bolting material is utilized to suit the operating conditions, taking into account the limitation of low yield strength bolts.

Ensure that the use of bolt lubrication is employed. For torque tightening methods Flexitallic recommends the use of molybdenum disulphide bolt lubrication or similar nickel based compound. Do not apply any lubricants when using PTFE coated fasteners. Consult with the coating manufacturers for product specific friction coefficients.

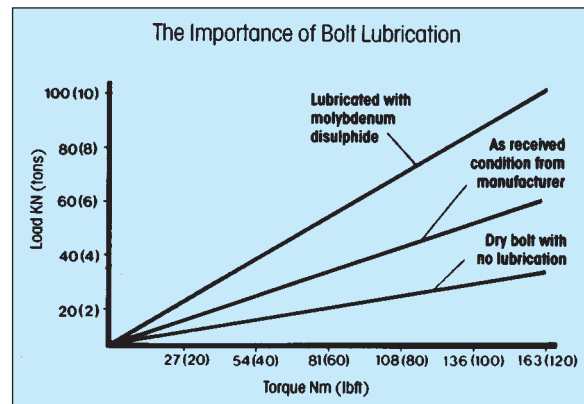
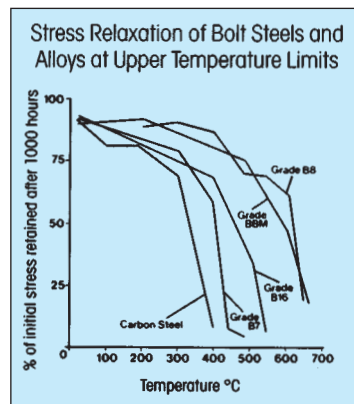

Tightening Procedures

Controlled tightening procedures should be used when installing spiral wound gaskets. Flexitallic recommends that the use of hydraulic tensioning equipment be considered where possible for bolt diameters 1 1/4" and above.

Please refer to Flexitallic's Design Criteria for further technical information.

USEFUL TECHNICAL DATA

TORQUE REQUIRED TO PRODUCE BOLT STRESS

The torque or turning effort required to produce a certain stress in bolting is dependent upon a number of conditions, some of which are:

1. Diameter of bolt.
2. Type and number of threads on bolt.
3. Material of bolt.
4. Condition of nut bearing surfaces.
5. Lubrication of bolt threads and nut bearing surfaces.

Generally, standard Flexitallic spiral wound gaskets will require a minimum of 30,000 psi bolt stress for proper gasket seating. However, it is the users responsibility to follow ASME Code calculations, and to ensure that sufficient pre-load is applied to withstand internal pressure, properly seat the gasket, and compensate for the effects of bolt relaxation.

The table below reflect the results of many tests to determine the relation between torque and bolt stress. Values are based on steel bolting well lubricated with a heavy graphite and oil mixture.

TORQUE DATA FOR USE WITH ALLOY STEEL STUD BOLTS

Load in Pounds on Stud Bolts when Torque Loads are Applied

TABLE
20

NOMINAL DIAMETER BOLT (Inches)	NUMBER OF THREADS (Per Inch)	DIAMETER AT ROOT OF THREAD (Inches)	AREA AT ROOT OF THREAD Sq. Inch	STRESS					
				30,000 PSI		45,000 PSI		60,000 PSI	
				Torque Ft/lbs	Compression lbs.	Torque Ft/lbs	Compression lbs.	Torque Ft/lbs	Compression lbs.
1/4	20	.185	.027	4	810	6	1215	8	1620
5/16	18	.240	.045	8	1350	12	2025	16	2700
3/8	16	.294	.068	12	2040	18	3060	24	4080
7/16	14	.345	.093	20	2790	30	4185	40	5580
1/2	13	.400	.126	30	3780	45	5670	60	7560
5/8	12	.454	.162	45	4860	68	7290	90	9720
3/4	11	.507	.202	60	6060	90	9090	120	12120
7/8	10	.620	.302	100	9060	150	13590	200	18120
1	9	.731	.419	160	12570	240	18855	320	25140
1 1/8	8	.838	.551	245	16530	368	24795	490	33060
1 1/8	8	.963	.728	355	21840	533	32760	710	43680
1 1/4	8	1.088	.929	500	27870	750	41805	1000	55740
1 3/8	8	1.213	1.155	680	34650	1020	51975	1360	69300
1 1/2	8	1.338	1.405	800	42150	1200	63225	1600	84300
1 5/8	8	1.463	1.680	1100	50400	1650	75600	2200	100800
1 3/4	8	1.588	1.980	1500	59400	2250	89100	3000	118800
1 7/8	8	1.713	2.304	2000	69120	3000	103680	4000	138240
2	8	1.838	2.652	2200	79560	3300	119340	4400	159120
2 1/4	8	2.088	3.423	3180	102690	4770	154035	6360	205380
2 1/2	8	2.338	4.292	4400	128760	6600	193140	8800	257520
2 3/4	8	2.588	5.259	5920	157770	8880	236655	11840	315540
3	8	2.838	6.324	7720	189720	11580	284580	15440	379440

Reprinted with permission of Crane Co. (Page 383, Crane No.60 Valve Catalog.)

USEFUL TECHNICAL DATA

BOLTING DATA FOR ASME B16.5 & BS 1560 FLANGES

TABLE 21

NOMINAL PIPE SIZE	CLASS 150				CLASS 300				CLASS 400				CLASS 600			
	FLANGE DIA.	NO. OF BOLTS	BOLT DIA.	B.C. DIA.	FLANGE DIA.	NO. OF BOLTS	BOLT DIA.	B.C. DIA.	FLANGE DIA.	NO. OF BOLTS	BOLT DIA.	B.C. DIA.	FLANGE DIA.	NO. OF BOLTS	BOLT DIA.	B.C. DIA.
1/4	3 3/8	4	1/2	2 1/4	3 3/8	4	1/2	2 1/4	3 3/8	4	1/2	2 1/4	3 3/8	4	1/2	2 1/4
1/2	3 1/2	4	1/2	2 3/8	3 3/4	4	1/2	2 5/8	3 3/4	4	1/2	2 5/8	3 3/4	4	1/2	2 5/8
3/4	3 7/8	4	1/2	2 3/4	4 5/8	4	5/8	3 1/4	4 5/8	4	5/8	3 1/4	4 5/8	4	5/8	3 1/4
1	4 1/4	4	1/2	3 1/8	4 7/8	4	5/8	3 1/2	4 7/8	4	5/8	3 1/2	4 7/8	4	5/8	3 1/2
1 1/4	4 5/8	4	1/2	3 1/2	5 1/4	4	5/8	3 7/8	5 1/4	4	5/8	3 7/8	5 1/4	4	5/8	3 7/8
1 1/2	5	4	1/2	3 7/8	6 1/8	4	3/4	4 1/2	6 1/8	4	3/4	4 1/2	6 1/8	4	3/4	4 1/2
2	6	4	5/8	4 3/4	6 1/2	8	5/8	5	6 1/2	8	5/8	5	6 1/2	8	5/8	5
2 1/2	7	4	5/8	5 1/2	7 1/2	8	3/4	5 7/8	7 1/2	8	3/4	5 7/8	7 1/2	8	3/4	5 7/8
3	7 1/2	4	5/8	6	8 1/4	8	3/4	6 5/8	8 1/4	8	3/4	6 5/8	8 1/4	8	3/4	6 5/8
3 1/2	8 1/2	8	5/8	7	9	8	3/4	7 1/4	9	8	7/8	7 1/4	9	8	7/8	7 1/4
4	9	8	5/8	7 1/2	10	8	3/4	7 7/8	10	8	7/8	7 7/8	10 3/4	8	7/8	8 1/2
5	10	8	3/4	8 1/2	11	8	3/4	9 1/4	11	8	7/8	9 1/4	13	8	1	10 1/2
6	11	8	3/4	9 1/2	12 1/2	12	3/4	10 5/8	12 1/2	12	7/8	10 5/8	14	12	1	11 1/2
8	13 1/2	8	3/4	11 3/4	15	12	7/8	13	15	12	1	13	16 1/2	12	1 1/8	13 3/4
10	16	12	7/8	14 1/4	17 1/2	16	1	15 1/4	17 1/2	16	1 1/8	15 1/4	20	16	1 1/4	17
12	19	12	7/8	17	20 1/2	16	1 1/8	17 3/4	20 1/2	16	1 1/4	17 3/4	22	20	1 1/4	19 1/4
14	21	12	1	18 3/4	23	20	1 1/8	20 1/4	23	20	1 1/4	20 1/4	23 3/4	20	1 3/8	20 3/4
16	23 1/2	16	1	21 1/4	25 1/2	20	1 1/4	22 1/2	25 1/2	20	1 3/8	22 1/2	27	20	1 1/2	23 3/4
18	25	16	1 1/8	22 3/4	28	24	1 1/4	24 3/4	28	24	1 3/8	24 3/4	29 1/4	20	1 5/8	25 3/4
20	27 1/2	20	1 1/8	25	30 1/2	24	1 1/4	27	30 1/2	24	1 1/2	27	32	24	1 5/8	28 1/2
24	32	20	1 1/4	29 1/2	36	24	1 1/2	32	36	24	1 3/4	32	37	24	1 7/8	33

DIMENSIONS IN INCHES

TABLE 22

NOMINAL PIPE SIZE	CLASS 900				CLASS 1500				CLASS 2500			
	FLANGE DIA.	NO. OF BOLTS	BOLT DIA.	B.C. DIA.	FLANGE DIA.	NO. OF BOLTS	BOLT DIA.	B.C. DIA.	FLANGE DIA.	NO. OF BOLTS	BOLT DIA.	B.C. DIA.
1/2	4 3/4	4	3/4	3 1/4	4 3/4	4	3/4	3 1/4	5 1/4	4	3/4	3 1/2
3/4	5 1/8	4	3/4	3 1/2	5 1/8	4	3/4	3 1/2	5 1/2	4	3/4	3 3/4
1	5 7/8	4	7/8	4	5 7/8	4	7/8	4	6 1/4	4	7/8	4 1/4
1 1/4	6 1/4	4	7/8	4 3/8	6 1/4	4	7/8	4 3/8	7 1/4	4	1	5 1/8
1 1/2	7	4	1	4 7/8	7	4	1	4 7/8	8	4	1 1/8	5 3/4
2	8 1/2	8	7/8	6 1/2	8 1/2	8	7/8	6 1/2	9 1/4	8	1	6 3/4
2 1/2	9 5/8	8	1	7 1/2	9 5/8	8	1	7 1/2	10 1/2	8	1 1/8	7 3/4
3	9 1/2	8	7/8	7 1/2	10 1/2	8	1 1/8	8	12	8	1 1/4	9
4	11 1/2	8	1 1/8	9 1/4	12 1/4	8	1 1/4	9 1/2	14	8	1 1/2	10 3/4
5	13 3/4	8	1 1/4	11	14 3/4	8	1 1/2	11 1/2	16 1/2	8	1 3/4	12 3/4
6	15	12	1 1/8	12 1/2	15 1/2	12	1 3/8	12 1/2	19	8	2	14 1/2
8	18 1/2	12	1 3/8	15 1/2	19	12	1 3/8	15 1/2	21 3/4	12	2	17 1/4
10	21 1/2	16	1 3/8	18 1/2	23	12	1 7/8	19	26 1/2	12	2 1/2	21 1/4
12	24	20	1 3/8	21	26 1/2	16	2	22 1/2	30	12	2 3/4	24 3/8
14	25 1/4	20	1 1/2	22	29 1/2	16	2 1/4	25	-	-	-	-
16	27 3/4	20	1 5/8	24 1/4	32 1/2	16	2 1/2	27 3/4	-	-	-	-
18	31	20	1 7/8	27	36	16	2 3/4	30 1/2	-	-	-	-
20	33 3/4	20	2	29 1/2	38 3/4	16	3	32 3/4	-	-	-	-
24	41	20	2 1/2	35 1/2	46	16	3 1/2	39	-	-	-	-

DIMENSIONS IN INCHES

USEFUL TECHNICAL DATA

FACING DIMENSIONS FOR ASME B16.5 & BS 1560 FLANGES

CLASS 150, 300, 400, 600, 900, 1500 AND 2500

TABLE
23

NOMINAL PIPE SIZE	OUTSIDE DIAMETER See Note 3			I.D. OF LARGE & SMALL TONGUE See Notes 3 & 5 U	OUTSIDE DIAMETER See Note 3			I.D. OF LARGE & SMALL GROOVE See Note 3 See Note 5 Z	HEIGHT		DEPTH OF GROOVE OR FEMALE
	RAISED FACE, LAPPED, LARGE MALE, & LARGE TONGUES See Note 5 R	SMALL MALE See Notes 4&5 S	SMALL TONGUE See Note 5 T		LARGE FEMALE & LARGE GROOVE See Note 5 w	SMALL FEMALE See Note 4 See Note 5 X	SMALL GROOVE See Note 5 V		RAISED FACE CLASS 150 & 300 See Note 1	RAISED FACE LARGE & SMALL MALE & TONGUE CLASS 400, 600, 900 1500 & 2500 See Note 2	
1/2	1 3/8	22/32	1 3/8	1	1 7/16	25/32	1 7/16	1 5/16	1/16	1/4	3/16
3/4	1 11/16	15/16	1 11/16	1 5/16	1 3/4	1	1 3/4	1 1/4	1/16	1/4	3/16
1	2	1 3/16	1 7/8	1 1/2	2 1/16	1 1/4	1 15/16	1 7/16	1/16	1/4	3/16
1 1/4	2 1/2	1 1/2	2 1/4	1 7/8	2 9/16	1 9/16	2 5/16	1 13/16	1/16	1/4	3/16
1 1/2	2 7/8	1 3/4	2 1/2	2 1/8	2 15/16	1 13/16	2 9/16	2 1/16	1/16	1/4	3/16
2	3 5/8	2 1/4	3 1/4	2 7/8	3 11/16	2 5/16	3 5/16	2 13/16	1/16	1/4	3/16
2 1/2	4 1/8	2 11/16	3 3/4	3 3/8	4 3/16	2 3/4	3 13/16	3 5/16	1/16	1/4	3/16
3	5	3 5/16	4 5/8	4 1/4	5 1/16	3 3/8	4 11/16	4 3/16	1/16	1/4	3/16
3 1/2	5 1/2	3 13/16	5 1/8	4 3/4	5 9/16	3 7/8	5 3/16	4 11/16	1/16	1/4	3/16
4	6 3/16	4 5/16	5 11/16	5 3/16	6 1/4	4 3/8	5 3/4	5 5/8	1/16	1/4	3/16
5	7 5/16	5 3/8	6 13/16	6 5/16	7 3/8	5 7/16	6 7/8	6 1/4	1/16	1/4	3/16
6	8 1/2	6 3/8	8	7 1/2	8 9/16	6 7/16	8 1/16	7 7/16	1/16	1/4	3/16
8	10 5/8	8 3/8	10	9 3/8	10 11/16	8 7/16	10 1/16	9 5/16	1/16	1/4	3/16
10	12 3/4	10 1/2	12	11 1/4	12 13/16	10 9/16	12 1/16	11 3/16	1/16	1/4	3/16
12	15	12 1/2	14 1/4	13 1/2	15 1/16	12 9/16	14 5/16	13 7/16	1/16	1/4	3/16
14	16 1/4	13 3/4	15 1/2	14 3/4	16 5/16	13 13/16	15 9/16	14 11/16	1/16	1/4	3/16
16	18 1/2	15 3/4	17 5/8	16 3/4	18 9/16	15 13/16	17 11/16	16 11/16	1/16	1/4	3/16
18	21	17 3/4	20 1/8	19 1/4	21 1/16	17 13/16	20 3/16	19 3/16	1/16	1/4	3/16
20	23	19 3/4	22	21	23 1/16	19 13/16	22 1/16	20 15/16	1/16	1/4	3/16
24	27 1/4	23 3/4	26 1/4	25 1/4	27 5/16	23 13/16	26 5/16	25 3/16	1/16	1/4	3/16

DIMENSIONS IN INCHES

NOTES

- Regular facing for class 150 and 300 steel flanged fittings and companion flange standards is a 1/16" raised face included in the minimum flange thickness dimensions. A 1/16" raised face may be supplied also on the class 400, 600, 900, 1500, and 2500 flange standards, but it must be added to the minimum flange thickness.
- Regular facing for class 400, 600, 900, 1500, and 2500 flange thickness dimensions.
- Tolerance of plus or minus 0.016 in. 1/64" is allowed on the inside and outside diameters of all facings.
- For small male and female joints care should be taken in the use of these dimensions to insure that pipe used is thick enough to permit sufficient bearing surface to prevent the crushing of the gasket. The dimensions apply particularly on lines where the joint is made on the end of the pipe. Screwed companion flanges for small male and female joints are furnished with plain face and are threaded with American Standard Locknut Thread.
- Gaskets for male-female and tongue-groove joints shall cover the bottom of the recess with minimum clearances taking into account the tolerances prescribed in Note 3.

SPECIAL HEAT EXCHANGER GASKETS

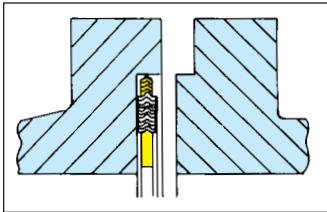
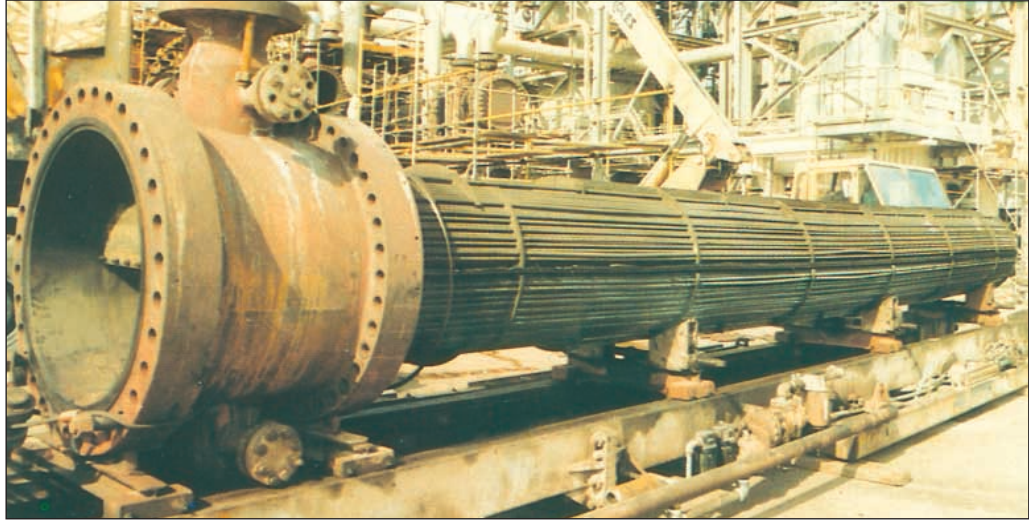

Special HE-CGI Gaskets with spiral wound outer ring (ALTERNATIVES HE-CG, HE-CGI)

Flexitallic special HE-CGI Gaskets with spiral wound outer ring are primarily designed for TEMA male and female flanges and are custom built to suit the design conditions of individual heat exchanger vessels. These gaskets are available in an extensive range of materials.

This style incorporates several special features, as follows:

1. The outer wound nose to ensure correct sealing element location in the flange recess.
2. A spiral wound sealing element to ensure a positive seal under fluctuating temperature and pressure conditions.
3. A solid metal inner ring to protect the sealing element and act as a compression stop. As an optional extra, inner rings can also be supplied with nylon location screws to secure the gasket to the flange on assembly.
4. Can be supplied with pass partition bars in any configuration. Pass bars are secured to the inner ring and can be supplied in either solid metal or double jacketed construction.

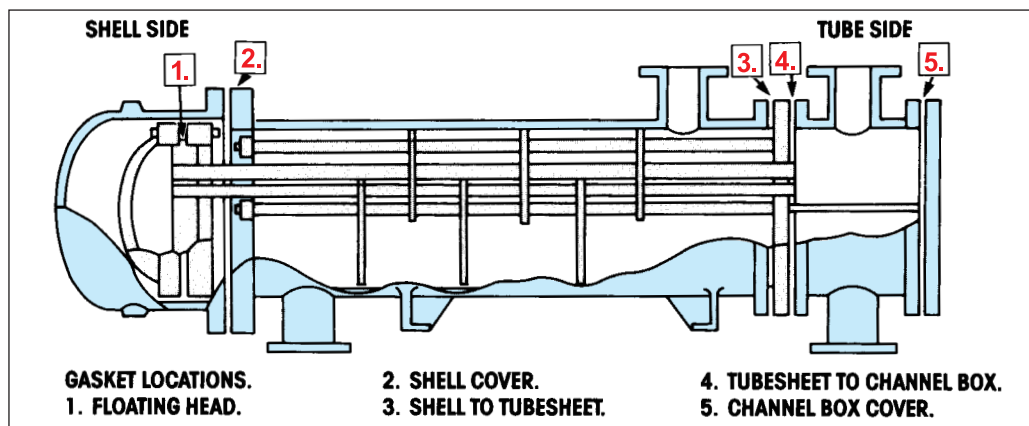
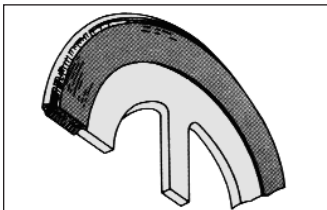
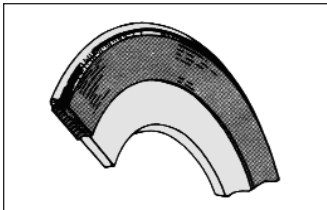

Heat exchangers with flat face or raised face flanges should utilize style CG and CGI spiral wound gaskets.

CARRIER RING GASKETS

The carrier ring concept consists of a solid metal ring with a machined recess in each face. Spiral wound gaskets are then located in each of the machined recesses.

This type of arrangement has been successfully used in sealing problematic flanges and vessels in the nuclear, power and petrochemical industries. The major benefits of the carrier ring assembly are due to the double spiral wound gasket being present. This results in a very high recovery gasket, ensuring that the bolt load is maintained on the sealing elements when arduous pressure/temperature cycling occurs in service, thus maintaining a seal.

Carrier rings can be used on flat face, raised face or tongue and groove type flange,

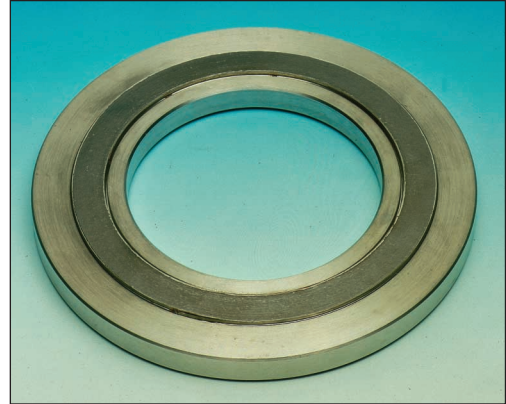

as well as non standard flange configurations. They can be supplied for both small and large diameter nominal bores up to class 2500 pressure rating. Carrier rings are also tailor made to suit specific flange arrangements and design conditions.



Typical Applications

The carrier ring concept has been extensively used in the power generation industries, petrochemical and nuclear industries. Typical applications are as follows:

Heat Exchanger
Operating Pressure: 2900 psi
Temperature: 200°C
Tube Sheet

H.P. Heaters, Fossil Fired Generators,
H.O.T. Construction, Steam Service
Operating Pressure: 700 psi
Temperature: 370°C

Materials Utilized
316L/Flexicarb®
17-7PH/Flexicarb®
Inc X750 HT (Special high recovery material)

Catalytic Crackers
720°C, Regenerators, 2980 mm OD
Hydrocarbon Service, Refineries

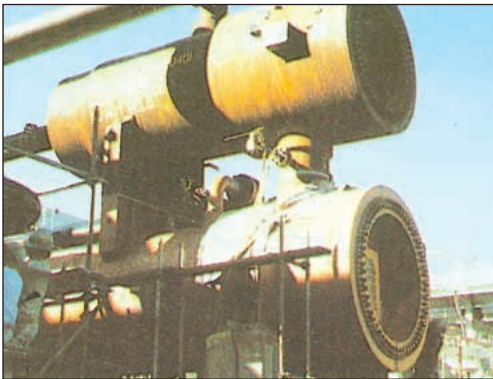

STYLE LS™ & LSI LOW STRESS RANGE OF SPIRAL WOUND GASKETS

The LS gasket offers the same high integrity seal associated with the spiral wound gasket however, the LS and LSI has been designed in such a way that compression and sealing requirements are achieved under very low seating stresses. These gaskets are intended for use on class 150 and 300 applications, where customers traditionally do not use spiral wound gaskets due to concerns about exceeding allowable design stresses.

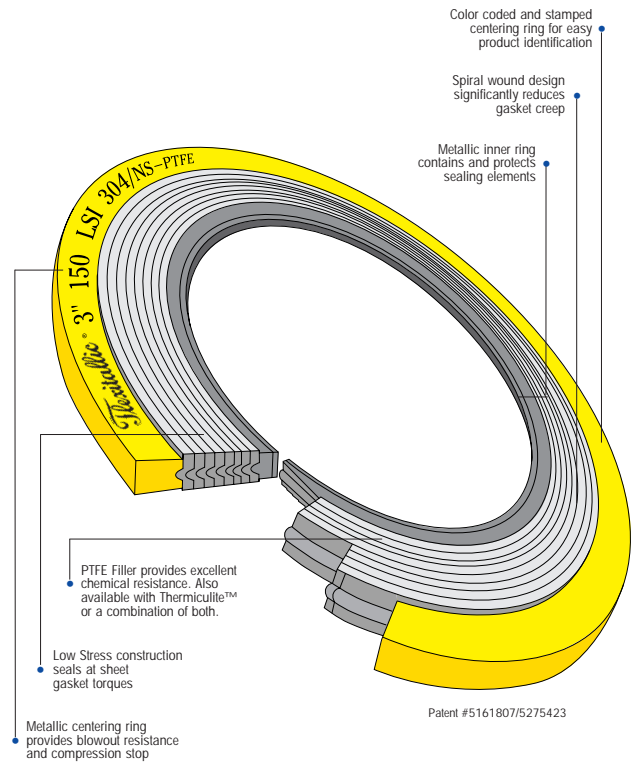
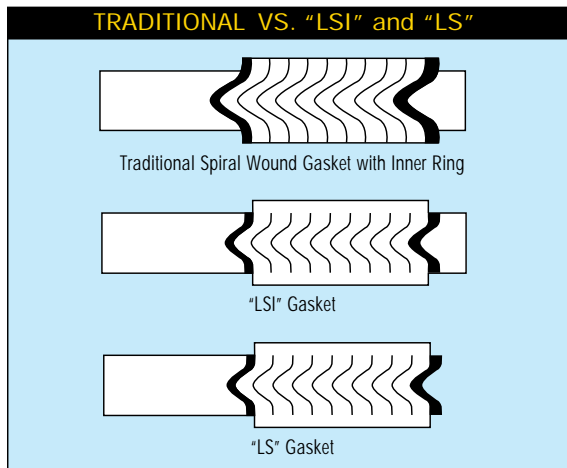

The traditional spiral wound gasket has its steel windings protruding above the compression stop; this requires a significant loading stress to compress the gasket to its optimum operating thickness. The LS and LSI gaskets have only soft Flexicarb or PTFE filler protruding above metal windings and guide ring; therefore as the gasket is compressed, the Flexicarb®, Thermiculle™ 836, or PTFE filler is readily compressed thus producing the sealing mechanism at an earlier stage as compared to the conventionally manufactured spiral-wound gasket.

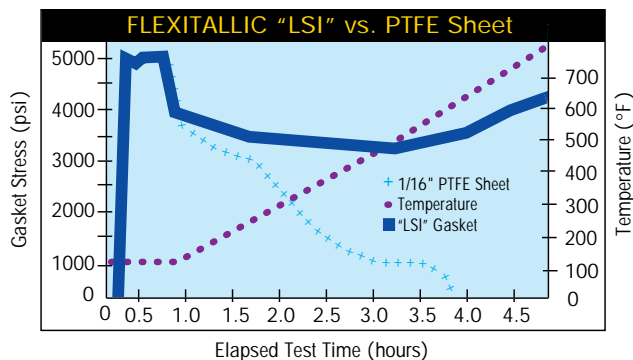

The "LSI" gasket retains more of its initial stress or tightness, even when subjected to high temperatures, unlike PTFE sheet gaskets.

AVAILABLE IN A VARIETY OF METALS,
ENGINEERED TO SUIT SPECIFIC APPLICATIONS.

LOWER BOLT STRESS-REDUCED FUGITIVE EMISSIONS

Flexitallic recommended minimum bolt torque figures for use with the "LSI" gasket on ASME/B16.5 flanges.*

NPS (Ins)	TORQUE FT. LBS.	NPS (Ins)	TORQUE FT. LBS.
1/2	25	5	83
3/4	25	6	83
1	25	8	83
1 1/4	25	10	133
1 1/2	25	12	133
2	50	14	204
2 1/2	50	16	204
3	50	18	296
3 1/2	50	20	296
4	50	24	417

Note: Minimum required torques may be even lower depending on gasket size and bolt material. Please contact Flexitallic's Technical Services Department for more information.

*Above torque values are for class 150 ASME flanges
TORQUE VALVES FOR 300 # AVAILABLE ON REQUEST.

SPIRAL WOUND GASKETS FOR BOILER CAP AND MANHOLE COVER ASSEMBLIES

Gaskets for boiler handhole, tubecap and manhole covers incorporating the unique Flexitallic spiral wound profile and specially manufactured with Flexicarb® filler, are ideal for corrosive, high pressure or temperature duties. Flexitallic's anticipation of developments in modern steam generating and engineering equipment and ability to design to specific requirements are the guarantee of the perfect seal at minimum maintenance cost with consistently high standards of performance.

- High safety factor related to specific operating conditions
- Compression loadings proportional to safe stresses of cover assemblies
- Resilient under concentrated and fluctuating loads
- Prolonged trouble-free service
- Reduced seat cleaning time

Style M & MC & MCS

Spiral Wound Gaskets for Boiler Manhole Cover Assemblies

The Flexitallic manhole gasket spiral constructions incorporate modified compression values to provide seating loads within the normal range of cover assemblies.

Size/Range Specification

Available in circular, obround, and oval shapes to suit standard manhole plate configurations.



Style M Gaskets



Style MC Gaskets

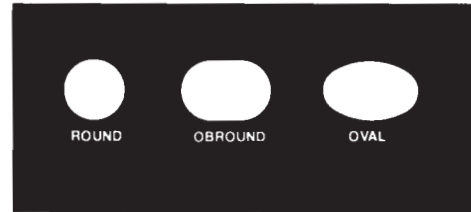

Standard Style M

Style T

Spiral Wound Gaskets for Boiler Handhole and Tubecap Assemblies

The design features of the basic Flexitallic spiral wound construction alleviate the need for sealing compound. Particularly suitable where old and pitted faces have rendered other gaskets ineffective.

Size/Range Specification

Available in several standard shapes:-



Basic spiral construction of Style T Gaskets

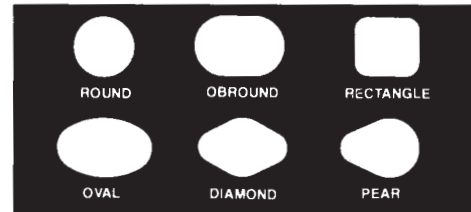

Style T Pear

Supplied in thicknesses of 3.2mm (0.125in.) or 4.5mm (0.175 in.). The standard thickness of 4.5mm (0.175in.) is recommended for use in assemblies where the seat is relatively broad and bolting load is low.

Materials

Standard materials are Type 304 Stainless Steel and Flexicarb windings. Special materials to suit specific operating conditions are available.

To Order

With all orders or inquiries please submit following:

- Name of boiler or equipment manufacturer
- Gasket style
- Dimensions of gasket
- Gasket thickness
- Flange width of gasket
- Pressure service rating
- Gasket material preference



Style T Square

STYLES M & MC FOR MANHOLE COVER ASSEMBLIES

TABLE
24

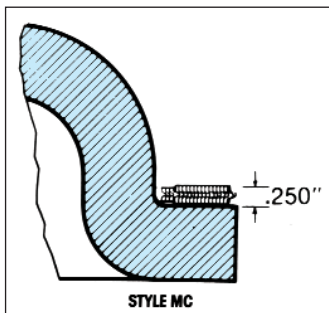
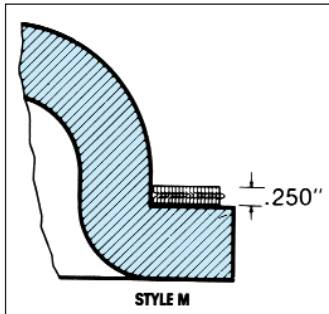
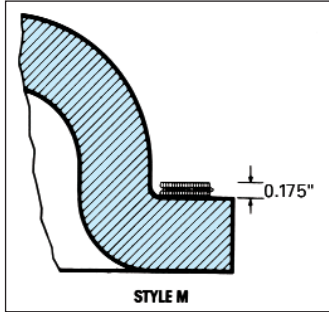

STYLE	NOMINAL I.D. DIMENSIONS (inches)	THICKNESS (inches)	FLANGE WIDTH (inches)
M-Oval	10 x 15	.250	¹⁵ / ₁₆
M-Oval	10 x 16	.250	¹⁵ / ₁₆
M-Oval	11 x 15	.250	¹⁵ / ₁₆
MC-Oval	11 x 15	.250	¹³ / ₁₆
M-Oval	11 x 15	.175	³ / ₄
M-Oval	11 x 15	.175	¹⁵ / ₁₆
M-Oval	11 x 15	.175	¹ / ₂
M-Oval	11 x 15	.175	1 ¹ / ₄
M-Oval	11 x 15	.250	1 ¹ / ₄
M-Oround	11 ¹ / ₁₆ x 14 ⁷ / ₈	.250	¹⁵ / ₁₆
M-Oround	11 ¹ / ₁₆ x 15 ¹ / ₁₆	.250	¹⁵ / ₁₆
M-Oval	12 x 16	.250	¹⁵ / ₁₆
MC-Oval	12 x 16	.250	¹³ / ₁₆
MOval	12 x 16	.175	¹ / ₂
M-Oval	12 x 16	.175	³ / ₄
M-Oval	12 x 16	.175	¹⁵ / ₁₆
M-Oval	12 x 16	.175	1 ¹ / ₄
M-Oval	12 x 16	.250	1 ¹ / ₄
M-Oround	12 x 16	.250	¹⁵ / ₁₆
M-Oround	12 x 16	.250	1 ¹ / ₄
MC-Oval	12 ⁷ / ₈ x 16 ⁷ / ₈	.250	¹³ / ₁₆
M-Oround	14 x 16	.175	³ / ₄
M-Round	14	.175	³ / ₄
M-Round	16 ¹ / ₁₆	.175	³ / ₄

NOTE: When ordering gaskets specify operating pressure and temperature and type of steel desired.

FLEXITALLIC STYLE MCS SPIRAL WOUND GASKETS

In keeping with our tradition of taking a leadership role in the gasket industry we are pleased to introduce the Flexitallic style MCS spiral wound gasket for use on boiler manhole cover assemblies. The style MCS gasket is an exclusive Flexitallic design, consisting of a Flexitallic spiral wound gasket with an integral solid metal inner and/or outer ring. The spiral wound sealing element provides resilience, strength, blowout resistance and superior sealability. The solid metal rings prevent over-compression of the gasket, which is especially important on high pressure boilers. In addition, the rings provide stability and facilitate proper positioning of the gasket on the cover which prevents pinching, shouldering, and other gasket damage resulting from misalignment, irregular plate contours and fillets.

Flexitallic style MCS spiral wound gaskets are available in a wide range of materials for standard, as well as special design manhole cover assemblies, in pressure classes of 0-499 psi, 0-999 psi, and 1000 psi and higher. For additional information on Flexitallic style MCS spiral wound gaskets, contact the Flexitallic plant nearest you.

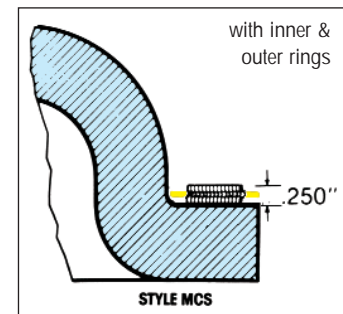
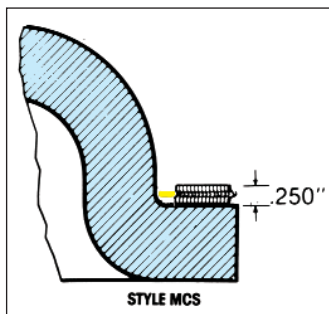

THE BAKER*GASKET

FOR HF ACID & OTHER HAZARDOUS CHEMICAL APPLICATIONS

Problem

A leak occurs on HF service

- HF can attack the bolts causing bolt failure.
- A small emission goes undetected.

Solution

- Prevents HF attacking the bolts.
- Early detection of small leaks.
- Containment of HF emissions.
- Improves maintenance (detect & repair).
- Requires no modification to the flanges.
- Designed to suit Class 150 & 300 flanges.
- Contains no respirable fibers.

What are the benefits?

The Baker gasket offers the user the reliability of a spiral wound gasket with the additional back-up of an emissions containment system should a leak occur. Reduced maintenance costs through an improved 'Detect & Repair' program. Improvements in plant operators Health & Safety profile.

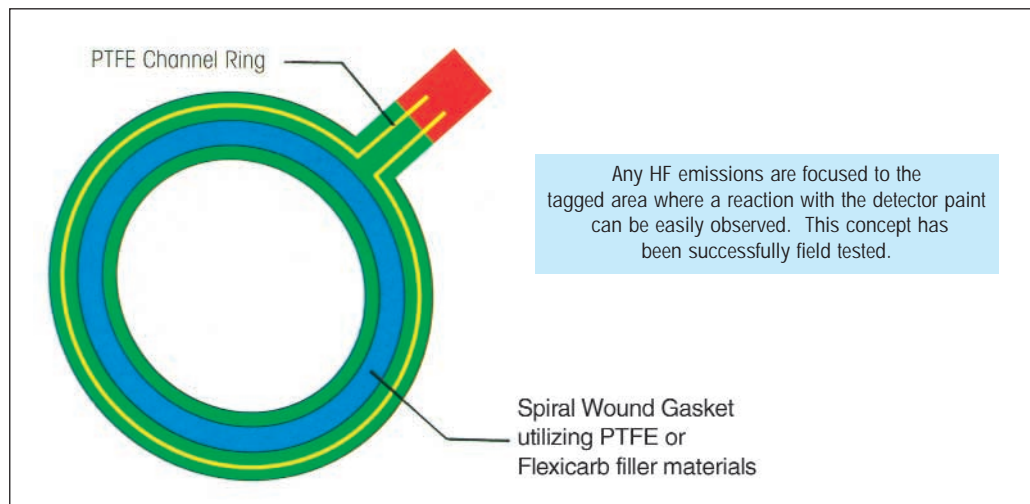
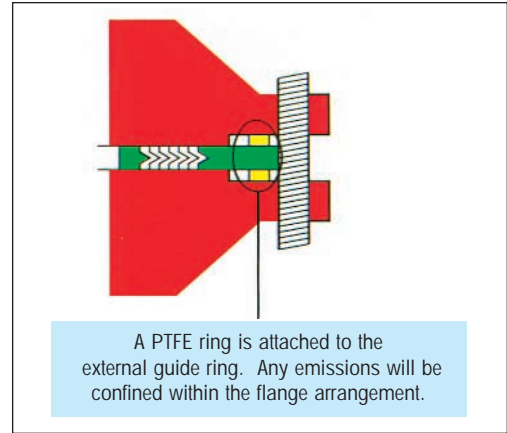
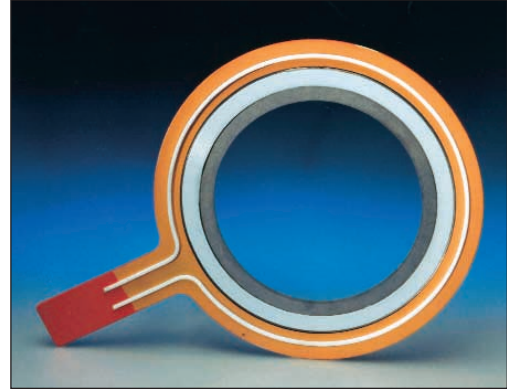

*Patent Pending

Multi-Class Spiral Wound Gasket

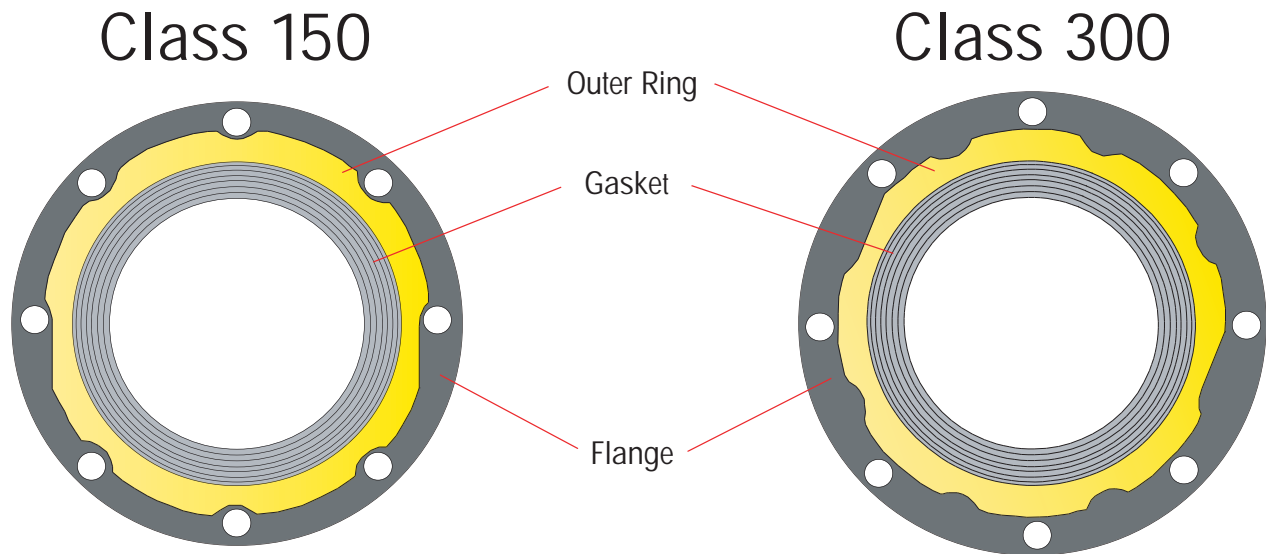

- One gasket accommodates both Class 150 and 300 flanges (Class 150 to 600 in NPS 1/2 through NPS 3)
- Reduces inventory requirements
- Easy to install... Less than half the studs
- Multiple metal windings & fillers available
- Also available with inner rings